

STATIC VAR GENERATOR

User manuals



Version: V2.0

Date: 2023.03



Catalogue

Preface	1
Safe	2
1.1 Transportation	5
1.2 Receiving and checking the equipment	5
1.3 Packaging of the module	5
1.4 Storage	6
Chapter II Product Overview	7
2.1 Appearance and composition of the products	8
2.1.1 Appearance	8
2.1.2 Wall-mounted hanging ear	9
2.2 Overall dimensions	9
2.2.1 Rack-type machine	10
2.2.2 Wall-hanging type	10
2.2.3 Vertical type	10
2.3 Technical parameters	11
2.4 Heat dissipation requirements	13
2.5 Implementation standards	13
Chapter III: System Installation	15
3.1 Tools	17
3.2 Installation environment	19
3.3 Mechanical installation	19
3.3.1 Rack-type installation	19
3.3.3 Vertical installation	22
3.4 Electrical connection	24
3.4.1 Port Overview	24
3.4.2 Power terminal	24
3.4.3 Communication port	26
3.4.4 Control ports	27
3.4.5 CT-Transformer	28
3.4.6 Single-machine power distribution	29
3.4.7 Distribution and distribution	31
Chapter IV: Test	36
run of a single machine	36
4.1 Check again	37
4.2 Power on the SVG	37
4.3 SVG shutdown	38
4.4 Manual / automatic operation	39
Chapter V Trial operation	40
5.1 Check again	41
5.2 Power on the SVG	41
5.3 SVG shutdown	42
5.4 Manual / automatic operation	43

Chapter VI A 4.3-inch screen menu	44
6.1 LCD open-home page	45
6.2 Data page	46
6.2.1 Power grid data	46
6.2.2 Load data	47
6.2.3 SVG data	48
6.3 Setup page	49
6.4 Fault page	51
6.5 Switch the machine page	52
6.6 Example of operation settings	53
6.6.1 Set the CT change ratio	53
6.6.2 Set the CT position	54
6.6.3 Set the startup mode	54
6.6.4 Reactive power setting	55
6.6.5 Set the phase sequence	56
Chapter VII Cabinet 7-inch HMI	57
7.1 7- inch HMI Presentation	58
Chapter VIII Maintenance and Maintenance	60
8.1 Attention before maintenance	61
8.2 Content and cycle of daily maintenance	61
Chapter IX. Common fault handling	64
9.1 Fault List	65
Appendix:	68
1. 400V-100kVar / 150kVar and 690V-120kVar appearance	68
2. Background forwarding instructions and interface definition	69
3. Comep Mode	70

Preface

To help you better use the product and protect you and the product safety, please carefully read and understand the relevant security information and about the equipment and user manual information before operating this product.

disclaimer

Following the contents of the user manual is a prerequisite for safe operation, and also a prerequisite for achieving the described performance features and product functions;

Our company shall not bear the responsibility for the material loss, economic loss or personal injury caused by the neglect of the product information;

Copyright Statement

We reserve the final interpretation right of this manual, prohibiting the reproduction, modification or dissemination of the contents of this manual without permission;

Technical changes

Please read and understand the information related to the product;

Please keep this manual during the service period of the product to avoid emergencies;

As the product is constantly updated and upgraded, and not without notice;

conformally connected space

Within the shelf life of the product, due to the quality problems of the product can enjoy free after-sales service;

Do not try to disassemble, repair, modify, upgrade the equipment, or all warranty services will fail.

Safe

This instruction is very important for the installation and use of a static reactive power generator (SVG). Ignoring these instructions may cause you physical injury and even death. The following safety information summarizes the safety measures required for the operation of the equipment and its components. Follow the safety tips and safety information to ensure your personal safety and avoid material and economic losses.

1. The symbol used

Safety information is marked with a symbol, according to the danger level, the danger level is shown as follows:

 attention to	Please always pay attention to possible dangerous situations, if not careful, may lead to mild injury.
---	--

 ta e	Please always pay attention to the dangerous situations that may occur, if not careful, may lead to moderate injury.
---	--

	Please always pay attention to possible dangerous situations, if not careful, may lead to serious injury.
---	---

 d t	Please be careful of electrical hazards.
--	--

2. Precautions

Some parts of the SVG equipment will inevitably produce hazardous voltage when operating electrical equipment. If not handled properly, serious physical injury or equipment damage may occur.

- ◆ SVG equipment is suitable for 0.2/0.4/0.48/0.69KV power supply system, and it is strictly prohibited to access to the power grid at will without understanding, so as not to cause equipment damage and personal safety harm!
- ◆ Improper use will damage the static reactive power generator and the connected equipment;
- ◆ All system installation or routine maintenance must be operated in the case of power failure;

- ◆ It is strictly prohibited to place combustible materials near the SVG equipment or install them in the environment containing explosive gas, otherwise there is a risk of fire or even explosion;
- ◆ Ensure that the input power is completely disconnected before installation and wiring, otherwise there is the risk of electric shock; after power on, never touch the SVG and other parts of the equipment;
- ◆ Bare cables, power terminal joints, and ungrounded live equipment may cause electric shock. Please ask the electrical engineer or professional technician to confirm that the SVG equipment is fully grounded and determine the live parts of the joints and components; please use appropriate safety protective clothing and test tools and follow the safety operation specifications;
- ◆ No maintenance of SVG equipment in working condition;
- ◆ When maintaining the product, be sure to cut off the main circuit and wait for at least 15 minutes to ensure that the AC side voltage drops to 0V and the internal capacitor is fully discharged;
- ◆ In wet conditions, the resistance of the human body will drop, at this time there may be a dangerous large current through the human body, so do not maintain and install SVG in a wet place. When it is impossible to avoid working under such conditions, stand on a dry rubber mat or dry board and use insulating gloves to keep the clothes dry and work with a companion.

3. Personnel with electrical qualifications

To avoid personal injury and material loss, only professionally qualified personnel are allowed to operate on SVG equipment, assembly, systems, and current circuits, and they must have the following knowledge:

- ◆ National and international regulations on electrical safety accidents;
- ◆ Power supply technical standard of safety prevention system and national standard of low-voltage electrical safety technical specification;
- ◆ Installation, commissioning, operation, disconnect, grounding and marking of electrical equipment;
- ◆ Basic requirements for personal protection.



Chapter I: Delivery, Inspection and Storage

- 1.1 Transport of the.....5
- 1.2 Receiving and checking the equipment.....5
- 1.3 Module Packaging.....5
- 1.4 Store the.....6

Chapter I. Arrival Inspection and Storage

1.1 Transportation

Each set of stationary reactive power generator (SVG) is generally transported through carton packaging (default carton, optional wooden box). buffer foam cotton and other protective items are placed in the carton, but they can not be inverted or tilted in the process of transportation and handling, so as to ensure that the filter can not be damaged in the process of movement.

1.2 Receiving and checking the equipment

SVG equipment has been professionally tested and inspected before leaving the factory, and is prepared according to the requirements of safe transportation. However, during the long-distance transportation, the fixed parts on SVG equipment may still become loose due to vibration turbulence and other reasons, so after receiving the equipment, please conduct the following inspection:

- ◆ After the equipment delivery arrives at the site, please check the goods according to the delivery list. If there are any abnormal conditions, such as damaged packaging, obvious deformation of equipment, inconsistent equipment quantity and the delivery list, please sign the carrier for confirmation, and contact the manufacturer immediately;
- ◆ When removing the equipment package, please pay attention to avoid violent removal. When you use scissors, pliers, etc. to remove the packaging, please be careful to avoid scratches and damage to the equipment;
- ◆ Check whether there is any external damage on the equipment, such as panel scratches, paint drop, depression, etc., and observe whether there are falling components and loose wiring in the equipment. In case of transportation damage should request logistics claim, need assistance in the claim process, please contact the company;
- ◆ Check the specifications and models. Our SVG equipment shell has a striking nameplate tag, which clearly describes the equipment model, rated capacity and other information. Please work carefully again to check the invoice and whether the goods are consistent with the delivery list.

1.3 Packaging of the module

The module packaging is divided into cartons and wooden boxes, generally the default carton. If you need a wooden box package, please note it in advance.

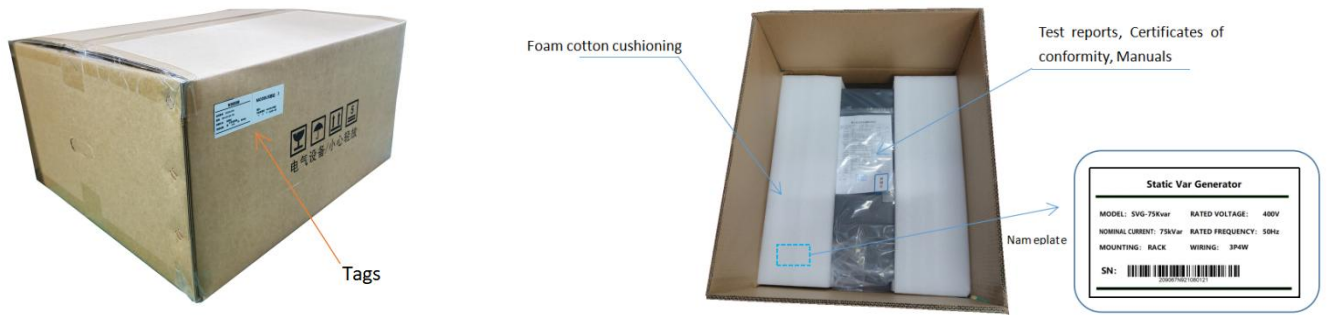
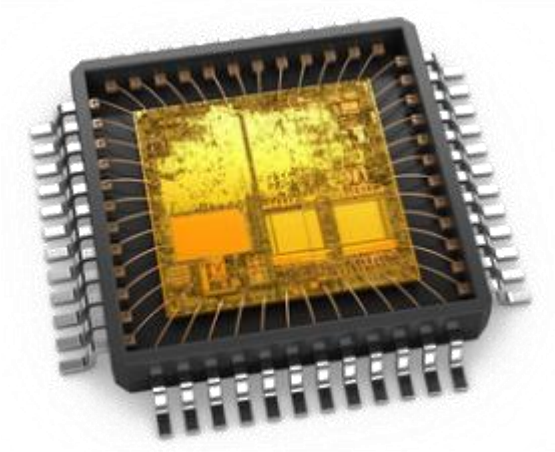

Figure 1-1 Appearance diagram of the rack type

1.4 Storage

- ◆ Packaging of SVG equipment avoids long-term outdoor storage, can be stored indoors for 6 months (from the date of delivery), if you need to store for a longer time, order can propose to the company to make a longer storage time packaging;
- ◆ If the SVG equipment is not installed immediately, the SVG equipment should be placed in the warehouse of dry, ventilated, no dust and corrosive substances, and no strong mechanical vibration and magnetic field in the warehouse;
- ◆ Storage environment temperature: (-45°C ~70°C), relative humidity of air: (5%~95%) (when lower than 25°C);
- ◆ When long-term storage needs, please regularly check to confirm whether the equipment packaging is moldy and damaged.



Chapter II Product Overview

2.1 Product appearance composition is.....	8
2.2 Overall dimensions.....	10
2.3 Technical Parameters.....	11
2.4 Heat dissipation requirements.....	13
2.5 Execution standard.....	12

Chapter II. Product Overview

2.1 Appearance and composition of the products

SVG series products can be divided into rack, wall mounted and vertical according to the installation mode. Each installation mode module has 200V / 400V / 480V and 690V voltage grade products, and the product capacity covers 50 kVar ~ 200 kVar.

The 4.3-inch LCD display is an optional module, and you can choose whether to have a screen according to the requirements.

2.1.1 Appearance

Take the rack-type 75 kVar, with the screen module as an example.

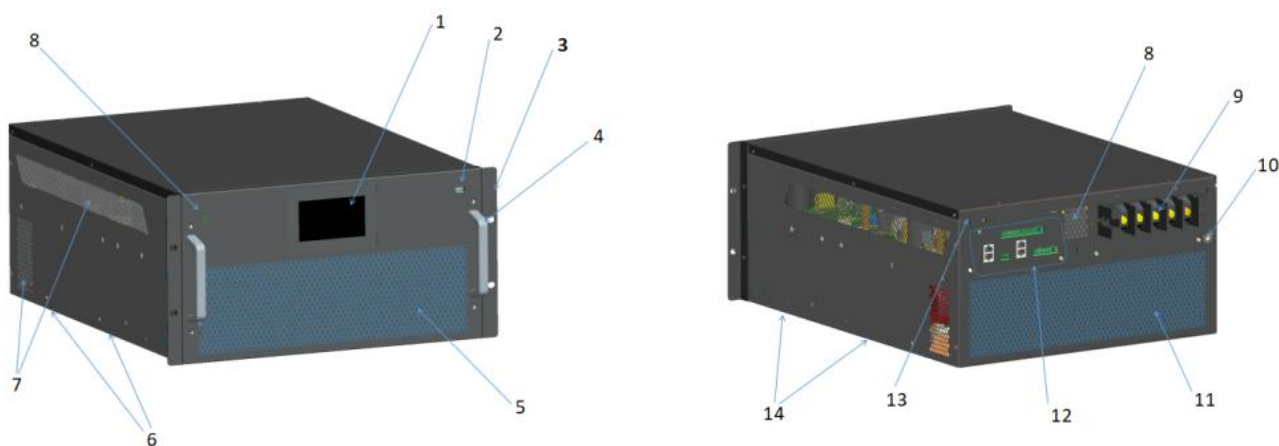

Figure 2-1 Frame-type appearance drawing

order number	explain	order number	explain
1	4.3-inch LCD LCD (optional)	8	Upper heat dissipation hole
2	USB port (can burn into the small screen program)	9	Power terminal
3	Rack type hanging ear	10	PE earth terminal
4	shake hands	11	The rear lower cooling hole
5	Lower cooling hole of the front panel	12	Control terminal
6	Wall-mounted hanging ear mounting	13	WIFI antenna interface

	hole position		
7	Side heat dissipation hole	14	Wall-mounted hanging ear mounting hole position

* SVG Rack series 400V voltage class 100kVar / 150kVar and 690V voltage class 120kVar products have the upper half of the front panel, others are consistent with the figure above, please refer to Appendix 1, without additional display here.

2.1.2 Wall-mounted hanging ear

Wall-mounted ears are standard items for wall-mounted modules, and rack modules of all capacity specifications can also be installed with corresponding wall-mounted ears to assist in reinforcement installation.

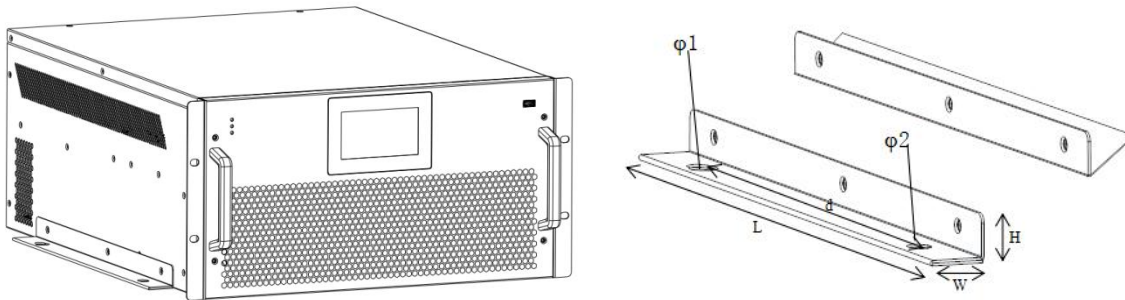

Figure 2-2 Hanging ear diagram

the classification of voltage	capacity	L*W*H (mm)	pitch of holes d(mm)	Installation aperture 1	Installation aperture 2
200V /400V /480V	35kVar	395*31.5*26.5	300	2-Φ12	2-Φ12*16
	50kVar	455*31.5*26.5	360	2-Φ12	2-Φ12*16
	75kVar	395*31.5*26.5	300	2-Φ12	2-Φ12*16
	100kVar	395*31.5*26.5	300	2-Φ12	2-Φ12*16
	150kVar	495*32.0*40.0	420	2-Φ13	2-Φ13*16
690V	120kVar	395*31.5*26.5	300	2-Φ12	2-Φ12*16

2.2 Overall dimensions

Under the same specification, the screen-free module and the screen module are the same as the overall size. Below, the screen module is taken as an example.

2.2.1 Rack-type machine

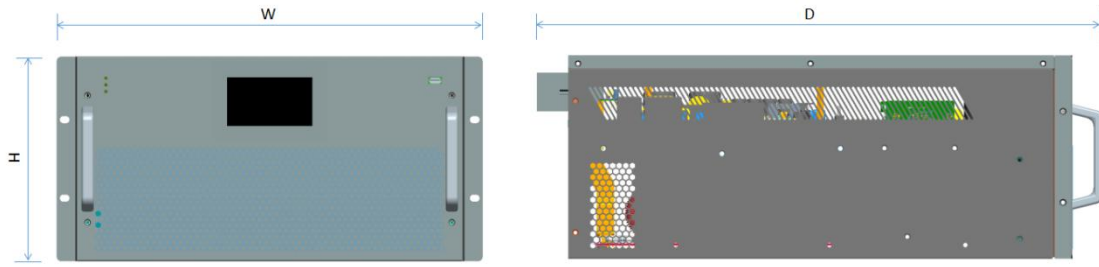

Figure 2-3 rack type dimensions

project	200V/400V/480V					690V
capacity (kVar)	35kVar	50kVar	75kVar	100kVar	150kVar	120kVar
Dimension W * D * H (mm)	359*538*200	399*626*200	484*646*232	554*656*250	674*715*250	569*697*250
weight (kg)	22	27	38	47	56	50

2.2.2 Wall-hanging type

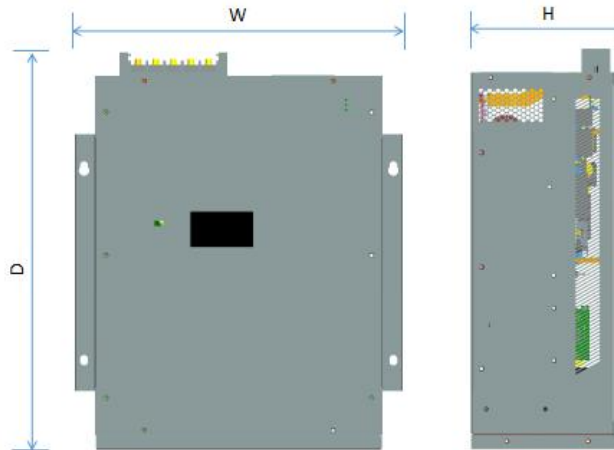

Figure 2-4 Wall-mounted dimensions drawing

project	200V/400V/480V					690V
capacity (kVar)	35kVar	50kVar	75kVar	100kVar	150kVar	120kVar
Dimension W * D * H (mm)	378*525*200	418*556*200	503*611*232	573*621*250	694*680*250	588*662*250
weight (kg)	22	27	38	47	56	50

2.2.3 Vertical type

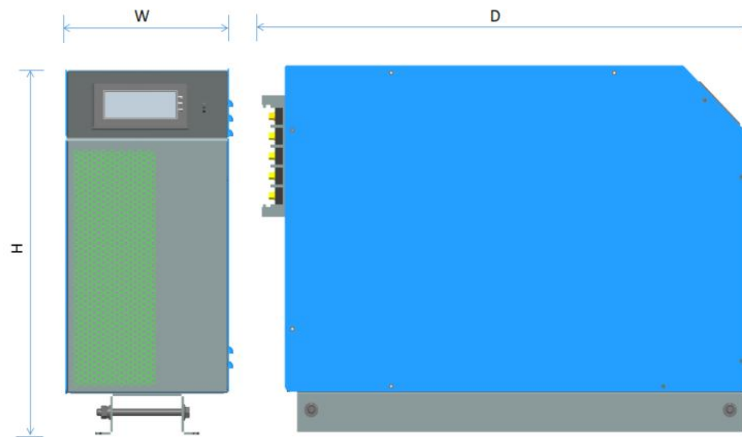

Figure 2-5 Vertical dimension drawing

project	200V/400V/480V					690V
capacity (kVar)	35kVar	50kVar	75kVar	100kVar	150kVar	120kVar
Dimension W * D * H (mm)	202.2*575*372.4	202.5*638*418	234.5*699*498	251.5*689*568	251.5*748*688	251.5*755*583
weight (kg)	22	27	38	47	56	50

2.3 Technical parameters

Rated voltage (V)	200/400	480	690
input voltage range	-20%~+20%	Maximum voltage: 500V	-20%~+10%
Single-module capacity (kVar)	35、50、75、100、150	35、50、75、100、150	120
frequency	50/60Hz (-10%~+10%)		
Scope of compensation	Capacitive and inductive continuously adjustable		
CT way to install	Open or closed loop (recommended in parallel case)		
CT installation site	Grid side / load side		
response time	≤10ms		
wiring system	Three-phase three-line / three-phase four-wire		
overload capacity	110% rated current and 1min at 120% rated current		
Circuit topology	Three-level topology		

switching frequency	20 kHz	
The number of machine	Modules and machines	≤ 20
	The HMI is under the control of the parallel machine	No more than 8 modules are combined
redundance	Any unit can become separate units	
Unbalanced governance	can provide sth	
SVC	can provide sth	
show	Screen / 4.3 / 7 inch screen (optional)	
communication interface	RS485 C kVar N Protocol, RJ 45 interface, for communication between modules	
Noise level	<56 dB max to <69 dB (depending on module or load condition)	
above sea level	The decrease was used at > 1500m	
ambient temperature	Operating temperature: -45°C~55°C, drop over 55°C	
	Storage temperature: -45°C~70°C	
humidity	5% ~ 95% RH, with no condensation	
cooling-down method	Intelligent air cooling	
levels of protection	IP20	
General structural and security issues	EN 62477-1(2012), EN 61439-1 (2011)	
EMC	EN / IEC 61000-6-4, of the kVar class	
attestation	CE, CQC	

2.4 Heat dissipation requirements

The SVG module adopts intelligent air cooling. During the design of the complete system, the heat dissipation design shall meet the following requirements:

the classification of voltage	Product capacity	Demand volume (L / Sec)	Minimum air inlet area (mm)	Minimum opening size of front and rear door panels (mm)
200V /400V /480V	35kVar	150	2.6×10^4	383*87
	50kVar	225	3.0×10^4	383*100
	75kVar	300	3.5×10^4	383*120
	100kVar	450	5.5×10^4	430*140
	150kVar	525	6.3×10^4	520*160
690V	120kVar	450	5.5×10^4	430*140

For example, the complete cabinet of SVG-400kVar should be designed to 4 times of the SVG-100kVar module (required air volume, minimum air inlet area, minimum opening size of front and rear door panels).

2.5 Implementation standards

Specification and standards mainly implemented by the equipment (but not limited to this)

GB / T 12325-2008, Power Quality, Power Supply Voltage Deviation;

GB12326-2008, Power Quality, Voltage fluctuation and Flash;

GB / T15576-2008 Low-voltage Complete Reactive Power Compensation Device;

DL / T597-1996 Technical Conditions for Low Voltage Reactive Compensation Controller;

GB7251.1-2005 Low-voltage Complete Switchgear and Control Equipment;

GB4208-2008 Shell Protection Grade;

GB4205-2010 Basic and Safety Rules for Human-machine Interface Identification;

GB11463-1989, Reliability Test of Electronic Measurement Instruments;

GB12747.1-2004 Self-healing Shunt capacitors for AC Power Systems with nominal voltage of 1 kV and below;

DL / T535-2009 Data Transmission Regulations of Power Load Management System;

JB / T9663-1999, Low-voltage Reactive Power Automatic Compensation Controller;

GB14594-1993 "Power Quality Public Grid Harmonics";

GB50150-2006 "Electrical Equipment Handover Test Standard";

GB50171-1992 Code for Construction and Acceptance of Engineering Plate, Cabinet and Secondary
Circuit Line of Electrical Equipme





Chapter III: System Installation

3.1 Tooling.....	17
3.2 Installation environment.....	18
3.3 Mechanical installation.....	19
3.4 Electrical Connections.....	22

Chapter III. System Installation

	<ul style="list-style-type: none"> ◆ The screen-less module is consistent with its installation and wiring mode; <p>The ◆ module can be monitored by a 4.3-inch screen (optional) or by a 7-inch screen (optional).</p>
---	--







	<ul style="list-style-type: none"> ◆ Provide sufficient air circulation in the installation environment. When the ambient temperature is high, please cool down the SVG equipment as required; ◆ Follow the installation instructions in this manual and related accessories; ◆ Install the rack-type module, please install it horizontally. Try not to tilt, inverted and other directions for installation; ◆ Install the wall-mounted module, try to install the wall-mounted vertically, do not side hanging or upside down; ◆ Install vertical modules to avoid tilt and lodging installation.
---	---



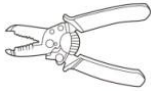

 	<p>Because ignoring the installation instructions can easily cause damage to the equipment and may endanger personal safety in serious cases, please strictly abide by the following regulations:</p> <ul style="list-style-type: none"> ◆ Before starting work, disconnect and make sure it is not closed by people and check that the SVG is dead! Temporary cover the adjacent live part with insulating material; ◆ In the process of operation and troubleshooting, please check whether there is a dangerous voltage in the environment in advance, and please close them off if necessary; ◆ When working on the electrical system, please wear the protective clothing and protective equipment according to the applicable guidelines; ◆ Before connecting the equipment / components, keep ground and ensure the equipment is power off; ◆ Do not contact the exposed or peeled wire, the twisted wire should be equipped with wire sleeve; ◆ Dangerous voltage is possible in all circuit parts connected to the power supply / grid;
--	--

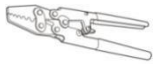
- ◆ Use a suitable line disconnecting switch / circuit breaker / fuse;
- ◆ Even after disconnection from the power supply / grid, dangerous voltage may still exist in the equipment or components (capacitor);
- ◆ Do not operate the equipment when the current transformer circuit is open;
- ◆ Do not make the SVG equipment run at full load for a long time, and do not set the parameters beyond the limit value that the equipment can bear;
- ◆ Note the warning and safety identification of all documents related to the equipment;
- ◆ Please pay attention to all warnings and safety signs in the site environment.

3.1 Tools

Prepare the tools that may be used for installation and wiring in advance. Only part of the tools that may be used are listed here for reference only.

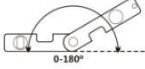
order number	tool	description	function
1		churn drill	Wall hole
2		One-word screwdriver	Remove, install screws and wiring
3		Phillips screwdriver	Remove, install screws and wiring
5		connection cover cutting pliers	wire stripping
6		inner hexagon spanner	Fixed module
7		Press wire clamp	Press the communication and control the terminal wiring And the crimded CT extension cord
8		multimeter	Check the cable wiring, Whether the grounding is reliable

9		marker pen	The punch mark
10		band tape	measured range
11		levelling instrument	Ensure the module level
12		Insulating and protective gloves	Wear it when installing the machine

3.2 Installation environment

(1) Site requirements

- ◆ SVG equipment must be installed in the electrical control room, the room must maintain a good ventilation environment;
- ◆ Air inlet and air outlet must have professional rain, dustproof, sand prevention treatment, necessary fire and rodent prevention treatment;
- ◆ If there are serious dust and fly ash problems on the installation site, it is recommended to specially protect SVG equipment to avoid the reduction of equipment efficiency, service life, failure and damage.

(2) Foundation requirements

- ◆ The installation surface must be smooth and dry, and the ground is strictly prohibited from standing water;
- ◆ Make sure that the ground does not shake horizontally, the plot is strong, and can withstand the weight of the SVG device.

(3) space requirement

- ◆ Sufficient space should be reserved in the left and right directions (at least 30cm) for heat dissipation;
- ◆ SVG equipment should be kept away from flammable and explosive articles and corrosive materials;
- ◆ A certain space should be reserved around the SVG equipment for operation, wiring and future maintenance;
- ◆ The installation position must comply with the fire safety regulations.

(4) Environmental requirements

- ◆ Full load at an altitude below 1500m; at 1500m-4000m; GB / T3859.2 per 100m increase;
- ◆ Humidity: 5~95%, no condensation;
- ◆ Ambient temperature: -45°C ~55°C.

3.3 Mechanical installation

Mechanical installation can be divided into frame installation, wall-mounted installation and vertical installation according to the module installation mode.

3.3.1 Rack-type installation

For rack installation, the cabinet can be fixed on the mounting post on both sides of the module (as shown below), or the installation effect can be strengthened by optional wall-hanging ears (reference 2.1.2).

The armrest of the front panel of the module is only held as an auxiliary installation, and is not used for load-bearing!

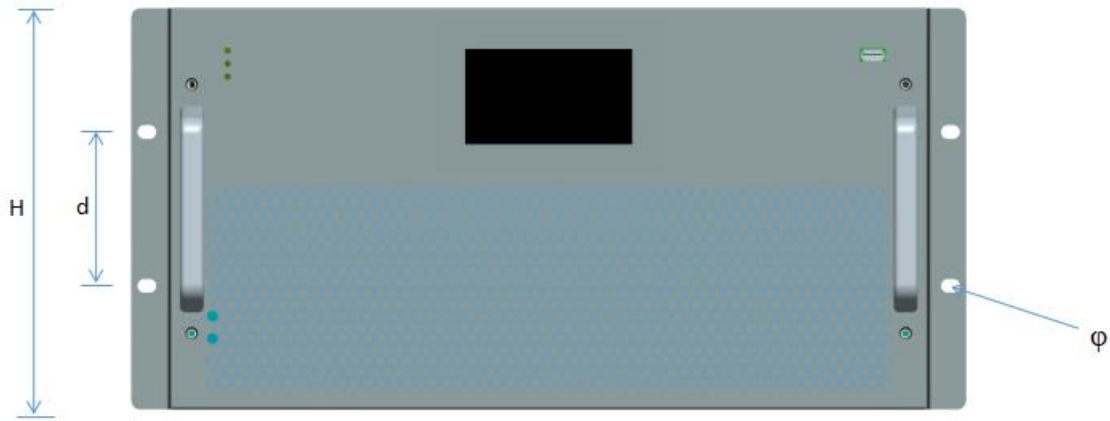
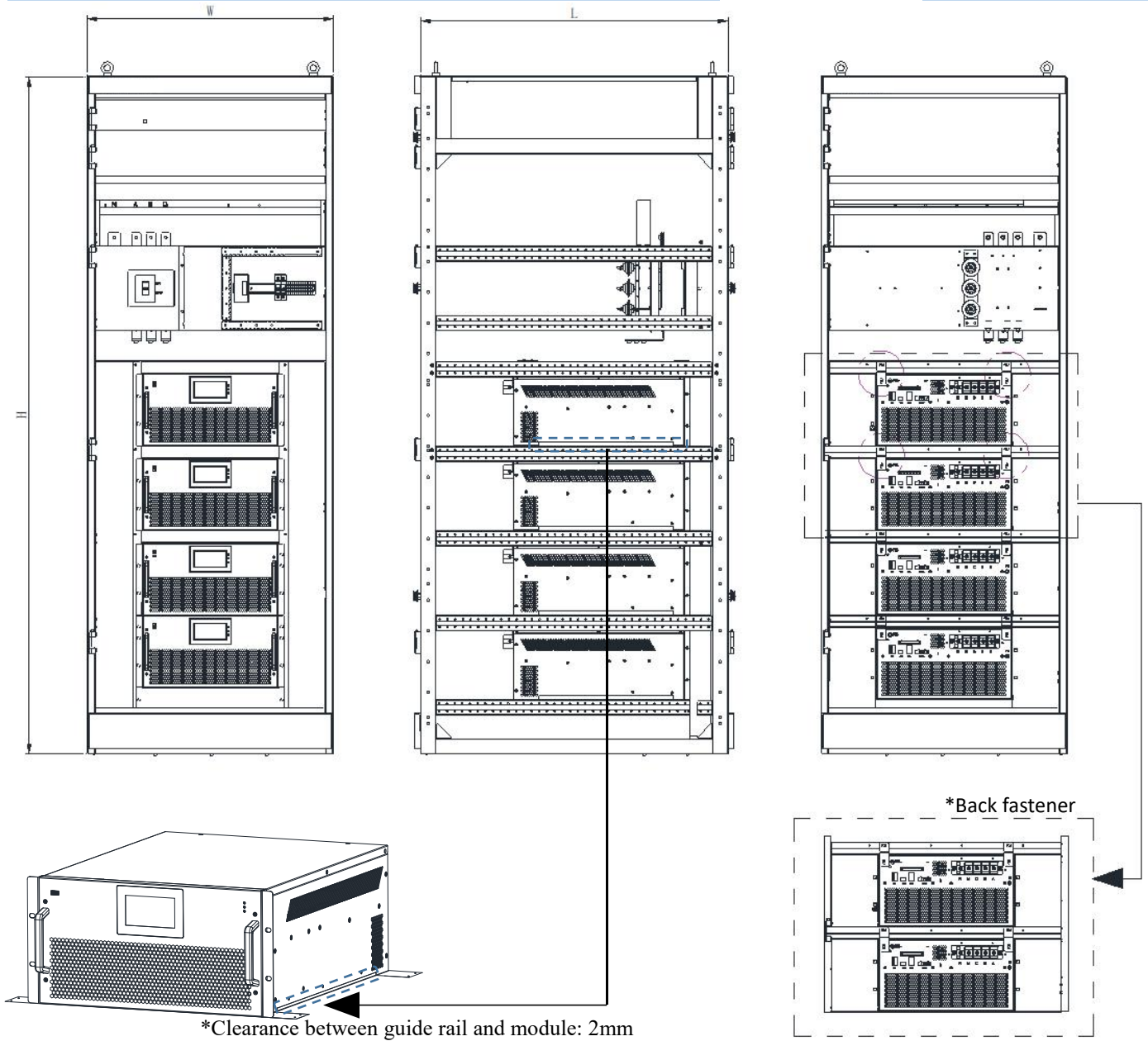

Figure 3-1 Frack front panel

the classification of voltage	capacity	H (mm)	d (mm)	Install aperture φ
200V /400V /480V	35kVar	200	89	4-φ8*11
	50kVar	200	89	4-φ8*11
	75kVar	232	89	4-φ8*11
	100kVar	250	89	4-φ8*11
	150kVar	250	89	4-φ8*11
690V	120kVar	250	89	4-φ8*11

Take the 300kVar reactive power compensation cabinet (composed of 475kVar modules) as an example:

	Recommended size W * L * H (mm)
Reactive compensation cabinet	800*800*2200
	800*1000*2200
	1000*1000*2200



3.3.2 Wall-mounted installation

When wall mounted installation, need to pass, the left and right wall hanging ear fixed in the cabinet or the hard wall.

voltage grade	capacity	Installation aperture 1	Installation aperture 2	pitch of holes d(mm)
200V /400V /480V	35kVar	2-Φ12	2-Φ12*16	300
	50kVar	2-Φ12	2-Φ12*16	360
	75kVar	2-Φ12	2-Φ12*16	300
	100kVar	2-Φ12	2-Φ12*16	300
	150kVar	2-Φ13	2-Φ13*16	420
690V	120kVar	2-Φ12	2-Φ12*16	300

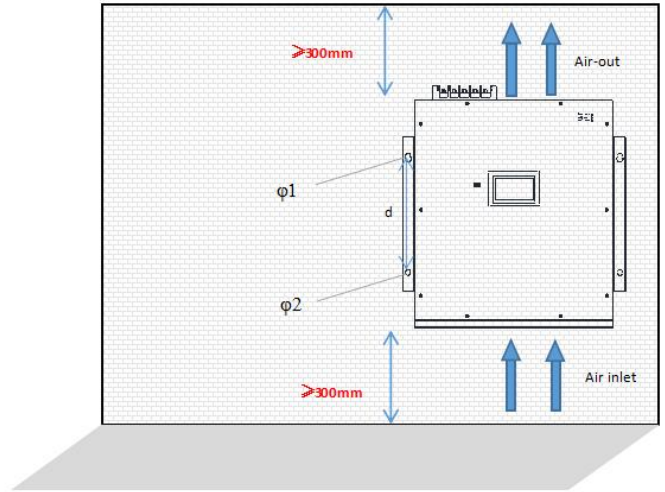
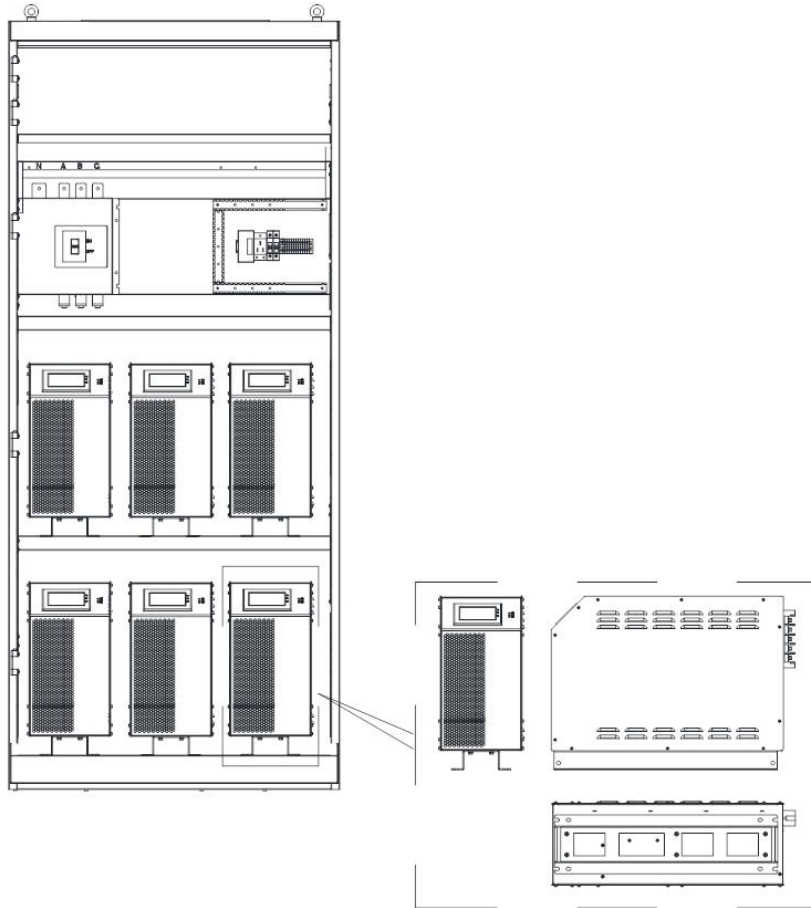

Figure 3-3 Wall-mounted installation drawing

3.3.3 Vertical installation

For vertical installation, the SVG module is fixed in the cabinet through the lower guide rail and screws. Take the 450kVar reactive power compensation cabinet (composed of 675kVar modules) as an example:

	Recommended size W * L * H (mm)
Reactive compensation cabinet	800*800*2200
	800*1000*2200
	1000*1000*2200



voltage grade	capacity	install The aperture 1	install The aperture 2	pitch of holes l(mm)	pitch of holes d(mm)	width w(mm)
200V /400V /480V	35kVar	4-Φ9	4-Φ9*15	511	440	140
	50kVar	4-Φ9	4-Φ9*18	595	440	140
	75kVar	4-Φ9	4-Φ9*14	625	550	140
	100kVar	4-Φ9	4-Φ9*14	640	550	140
	150kVar	4-Φ9	4-Φ9*14	686	600	215
690V	120kVar	4-Φ9	4-Φ9*14	687	616	140

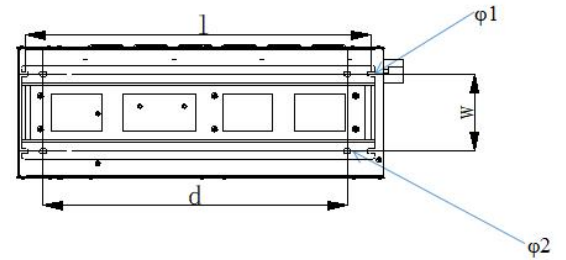

 attention to	<ul style="list-style-type: none"> ◆ It is recommended to put no more than 3 vertical modules in each layer of the cabinet; ◆ The beam and bottom of the cabinet should be thickened and strengthened to avoid being crushed due to the overweight module; ◆ The module installation center of gravity should be reduced as far as possible.
---	--

3.4 Electrical connection

3.4.1 Port Overview

SVG module port is divided into power terminal, communication port (can be divided into monitoring port, debugging port and parallel communication port), control port and CT.

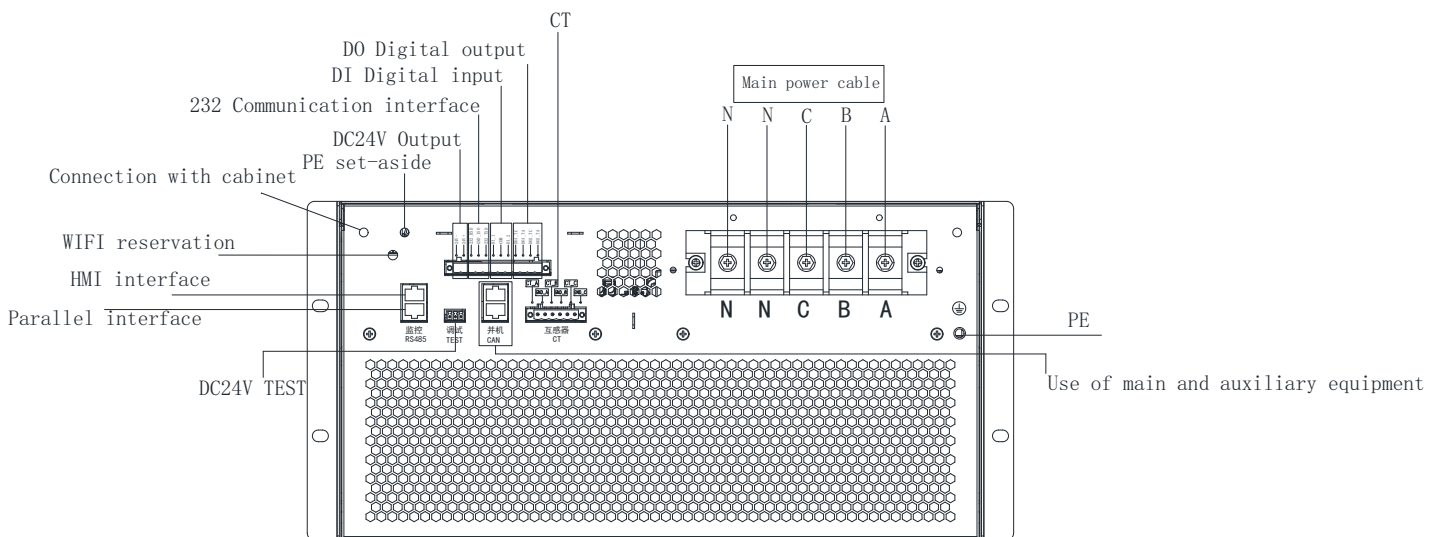



Figure 3-5 Back overview

Note: The power terminal N of the SVG module is only connected to one channel.

3.4.2 Power terminal

 warn	<ul style="list-style-type: none"> ◆ The wiring of the power terminal must be connected correctly, please be sure to check for many times: no leakage, no mixing, otherwise it may cause equipment failure or damage; ◆ SVG module power terminal N can be connected to one circuit; ◆ Please keep the power terminal dry and can be protected if necessary; ◆ Power terminal is conductive material, do not touch by hand!
---	--

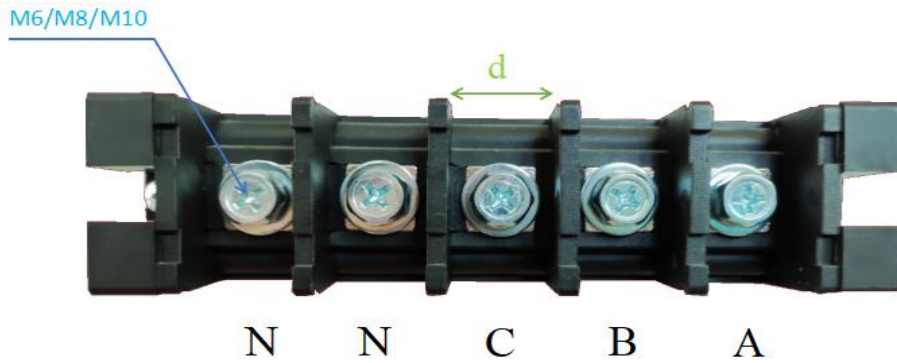

Figure 3-6 Power terminal diagram

(1) Meaning of terminals

project	explain
A	Phase A input
B	Phase B input
C	Phase C input
N	N phase input
PE	earth terminal

the classification of voltage	capacity	Power terminal specification	Terminal width d	PE ground stud
200V /400V /480V	35kVar	M6	13mm	M6
	50kVar	M8	23mm	M6
	75kVar	M8	23mm	M6
	100kVar	M8	23mm	M6
	150kVar	M10	30mm	M6
690V	120kVar	M8	23mm	M6

(2) Recommended cables

project	capacity	A/B/C (L1/L2/L3)	N	PE	fuse A
Power cable	35kVar	16mm ²	25mm ²	16mm ²	80
	50kVar	25mm ²	35mm ²	16mm ²	125
	75kVar	35mm ²	35mm ²	16mm ²	160
	100kVar	50mm ²	50mm ²	25mm ²	250
	150kVar	70mm ²	70mm ²	25mm ²	400
Copper core cable is recommended					

3.4.3 Communication port

	<p>◆ Do not conduct wiring debugging of the TEST port without authorization from the manufacturer! If the unauthorized wiring debugging and modification parameters, may cause equipment failure or even equipment damage, the company is not responsible for!</p>
---	--

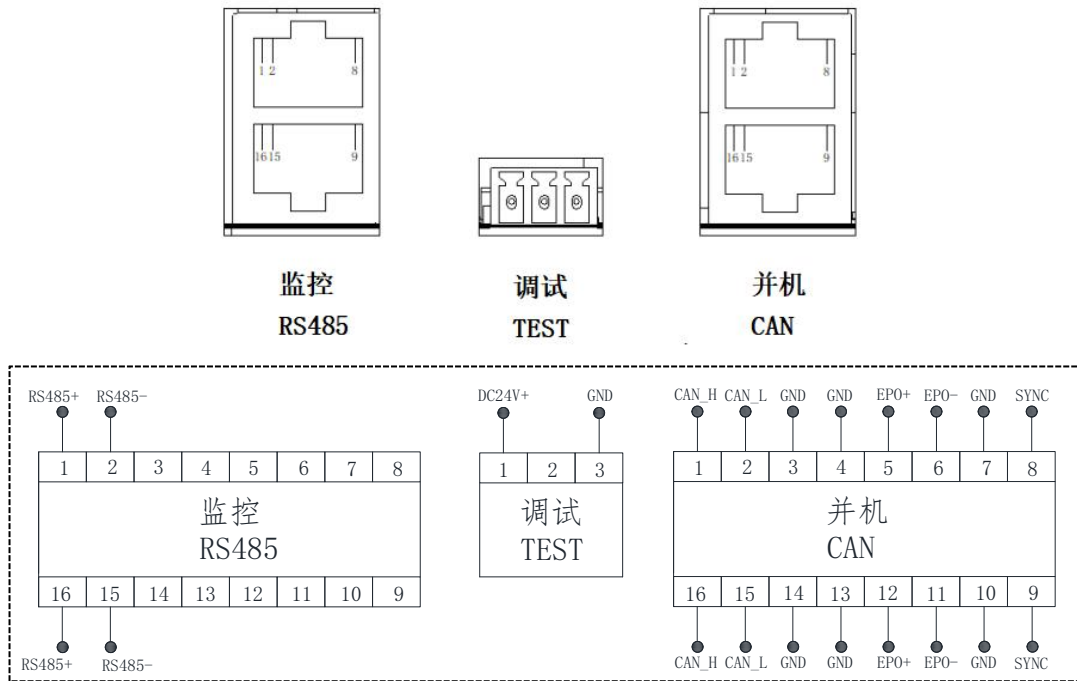

Figure 3-7, Communication port and definition figure

name	definition	explain	remarks
supervisory control RS485	RS485 Communication network port	<p>RS485 port: it is used to connect the background computer control system or external screen display to realize real-time monitoring of the entire SVG configuration system; except the first SVG module and the next SVG module to establish parallel connection (refer to Section 3.4.7)</p> <p>RS485 lower port: when only a single SVG module, can be empty; when multiple modules establish parallel communication, the lower port can be used to establish communication between parallel modules</p>	Follow the principle of "on to top, bottom to bottom"
shakedown test TEST	test debugging interface	TEST port is the special power interface for equipment debugging test (DC 24V input)	Commissioning special

parallel operation CAN	CAN And machine mouth	When the SVG module is normal, the CAN port can be used when the module controls the capacitor (optional).	Follow the principle of "on to top, bottom to bottom"
---------------------------	--------------------------	--	---

3.4.4 Control ports

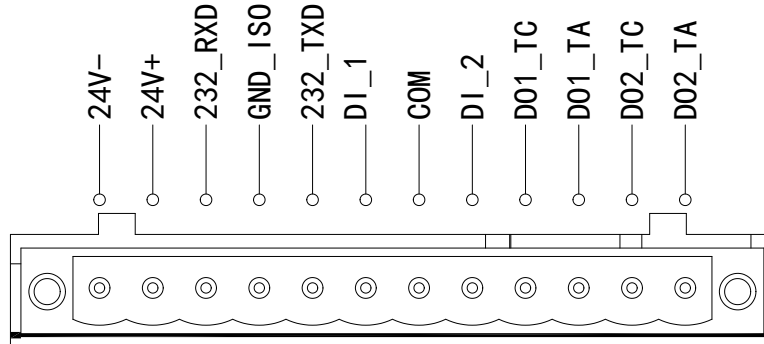

Figure 3-8 Control port diagram

project		Terminal symbol	Description of terminal function	Electrical specifications
Control terminal	24V output	24V-	24V minus end	24V output, 1A max
		24V+	24V is the end	
	RS232	232_RXD	232 Receiver	The RS232 interface, The 9,600 baud rate
		GND_ISO	232 Ground end	
		232_TXD	232 Send end	
	digital input	DI_1	Digital input to port 1	Light-coupled isolation input Input voltage: 9 ~ 24 Vdc Input impedance: 5k Ω
		COM	Digital input into the common end	
		DI_2	Digital input to port 2	
	numeric output	DO1_TA	Relay output: 1 neutral terminal	TA-TC: normally open contact; Contact capacity: 250 VAc / 2A (cos φ =1), 30 Vdc / 1A
		DO1_TC	Relay output 1 often start	
		DO2_TA	Relay output 2 neutral terminal	
		DO2_TC	Relay output 2 often start	

3.4.5 CT-Transformer

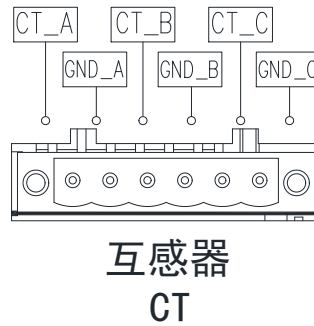

Figure 3-9 The CT port diagram



Interchangeator wiring:

project	explain	project	explain
CT_A	To the S1 end of the phase A CT	GND_A	To the S 2 end of the phase A CT
CT_B	To the S1 end of the phase B CT	GND_B	To the S 2 end of the phase B CT
CT_C	To the S1 end of the C-phase CT	GND_C	To the S 2 end of the C-phase CT

project	Parameter requirements		
	CT rated load	Cable section area	One-way wiring length
CT cable	5V A	2.5mm ²	≤10m
		4.0mm ²	10m~20m
	10V A	2.5mm ²	≤20m
		4.0mm ²	20~40m
	15V A	2.5mm ²	≤30m
		4.0mm ²	30~60m

- (1) Secondary power is greater than 1V A;
- (2) Accuracy requirement of 0.5 level or above;
- (3) The variable ratio range of CT is: 50 / 5~20000 / 5, and the variable ratio specification is selected according to 1.2~1.5 times of the system current. In the actual project, it can also be selected according to 1.5 times of the transformer capacity (400V), for example: the transformer capacity is 2000 kVA, 1.5 times the option is 3000 / 5;

(4) The secondary side of CT shall be reliable grounded (only one end can be grounded). The transformer sample cable is recommended with shielding twisted pair cable (RVVP), 15m with an inner diameter of 2.5mm^2 , 15m~30m line diameter to take 4mm^2 .

 attention to	<ul style="list-style-type: none"> ◆ External CT is recommended to be installed on the load side; ◆ Current transformer, as the external accessory of SVG, plays a vital role in the normal work of SVG, so the selection of external current transformer is very important, please be sure to refer to the above instructions for selection; ◆ If the current transformer is not connected correctly, it may cause insufficient filtering effect or equipment failure; ◆ Before installing the current transformer, first short circuit the secondary side and power off the equipment; ◆ Before separating the current transformer and SVG, it can be short circuit; ◆ After measuring the load current, a certain margin should be left for the transformer.
	<ul style="list-style-type: none"> ◆ When CT wiring, the outgoing terminals S1 and S 2 of CT are connected to SVG respectively, and the positive end (CT_A) and negative end (GND _ A) of the CT terminal of the device, refer to 3.5.5 and 3.5.6; ◆ The P1 end of CT is toward the power side and the P2 end is towards the load side; ◆ S1 and S2 of each transformer must correspond to the terminals of the corresponding mark, and it is strictly prohibited to open the second twice. Any violation of this article may cause the transformer to burn; ◆ Ensure the current transformer is in short circuit state until the CT connection terminals of SVG are connected.

3.4.6 Single-machine power distribution

Take the load-side sampling as an example:

P1 → P2 (Transformer orientation)
 SVG current sampling transformer CT

(Note: If the transformer is P2 → P1 facing the other way, you need to change the "CT direction" via the HMI on the small screen.)

Connection to other busbars

TMV-3 [3 (125×10)]							
0.4KV							
Primary main wiring							
Zero row TMV-2 (125×10)							
Switchgear number	MT1	1AA1	1AA2	1AA3	1AA4	1AA5	1AA6
Switchgear models		GGD	GGD	GGD	GGD	GGD	GGD
Loop name		Inlet cabinet		Outlet cabinet	Outlet cabinet	Outlet cabinet	Contact cabinet
Knife switches HD138X							
Frame intelligent circuit breakers							
Circuit Breaker		MT63/3P 5000A		MT32/3P 2500A	MT32/3P 2500A		
Circuit Breaker							
Circuit Breaker		SCB13-2500KVA (10) ±2.5%/0.4KV					
Circuit Breaker		Dyn11					
Current transformers		BH-0.66					
ACR220E							
		5000/5		3000/5	3000/5	800/5	5000/5
		ACR220E 5000/5		ACR220E 3000/5	ACR220E 3000/5	ACR220E 800/5	ACR220E 5000/5
Surge protectors							
		OVR BT2 3N-70-440					
Dimensions (W×H×D)		1200×2200×1000	800×1000×2200	800×1000×2200	800×2200×1000	800×2200×1000	1200×2200×1000

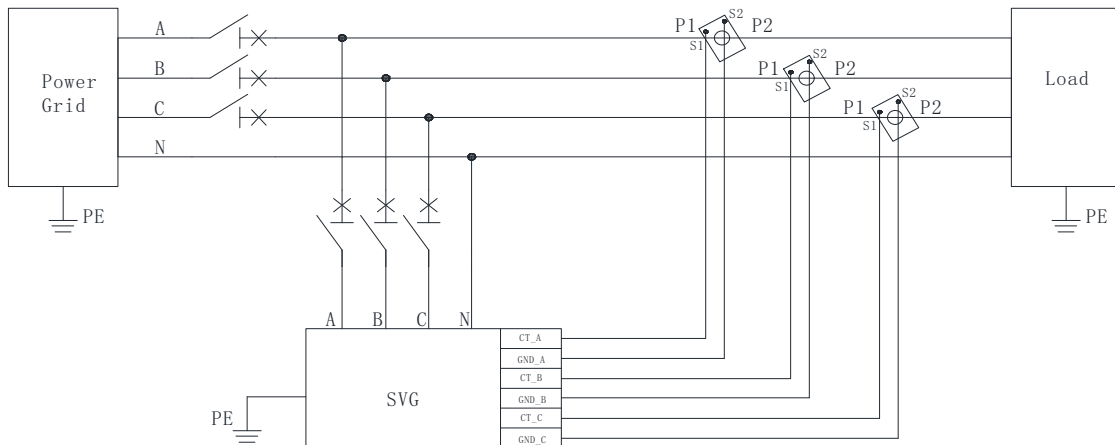

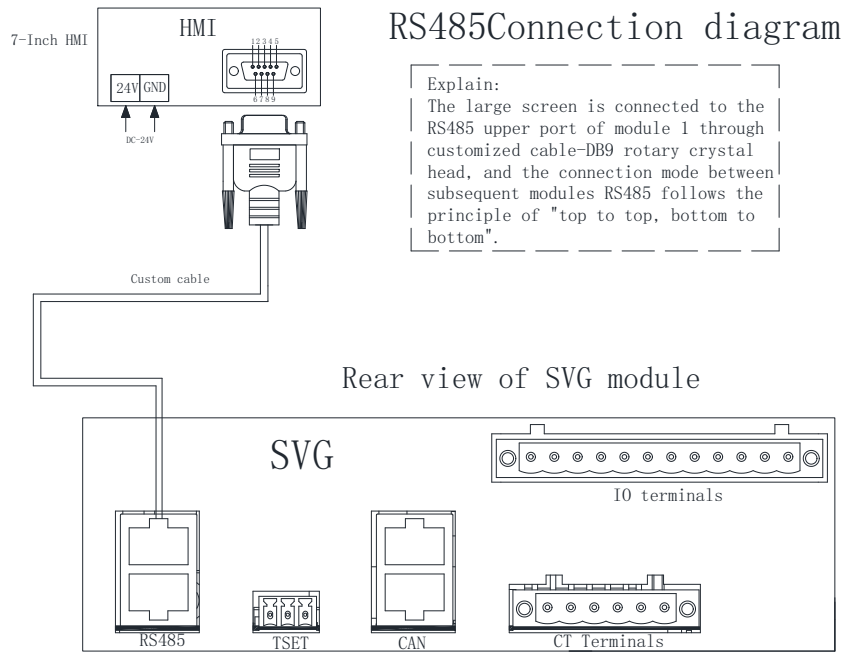

Figure 3-10, single-machine power distribution diagram



attention to

- ◆ The circuit diagram shown here is simplified (three phase and four lines), please refer to the physical object;
- ◆ **When running, the CT wiring mode of the power side and the load side is consistent;**
- ◆ When the external large screen is connected, DB9 special cable (available) shall be used between the large screen and the module, and connected to the upper port of RS485;
- ◆ Large screen power can be external wiring power, but also from the SVG module back DC24V "+, -" terminal wiring power;
- ◆ With background forwarding communication function is optional content, compared with the wiring without forwarding function, more cable and adapter, our company can provide supporting;
- ◆ **Background forwarding instructions and interface definition are shown in Appendix 2.**

3.4.7 Distribution and distribution



- ◆ The power connection is the same as the single machine;
- ◆ When the power side sampling, two sets of consistent transformer can be installed to do subtraction;
- ◆ CT side side cable recommended to use series connection method;
- ◆ The wiring between parallel modules with different capacities (100kVar + 50 kVar) is consistent with the wiring between modules with the same capacity (100kVar + 100kVar);
- ◆ When parallel communication, the large screen can take power from the DC24V of one of the modules.
- ◆ **The wiring principle of the cabinet is the same as that of the machine. The wiring between the cabinet can be long with the parallel cable, which is not explained here. For details, please consult our engineer.**

(1) CT load-side sampling

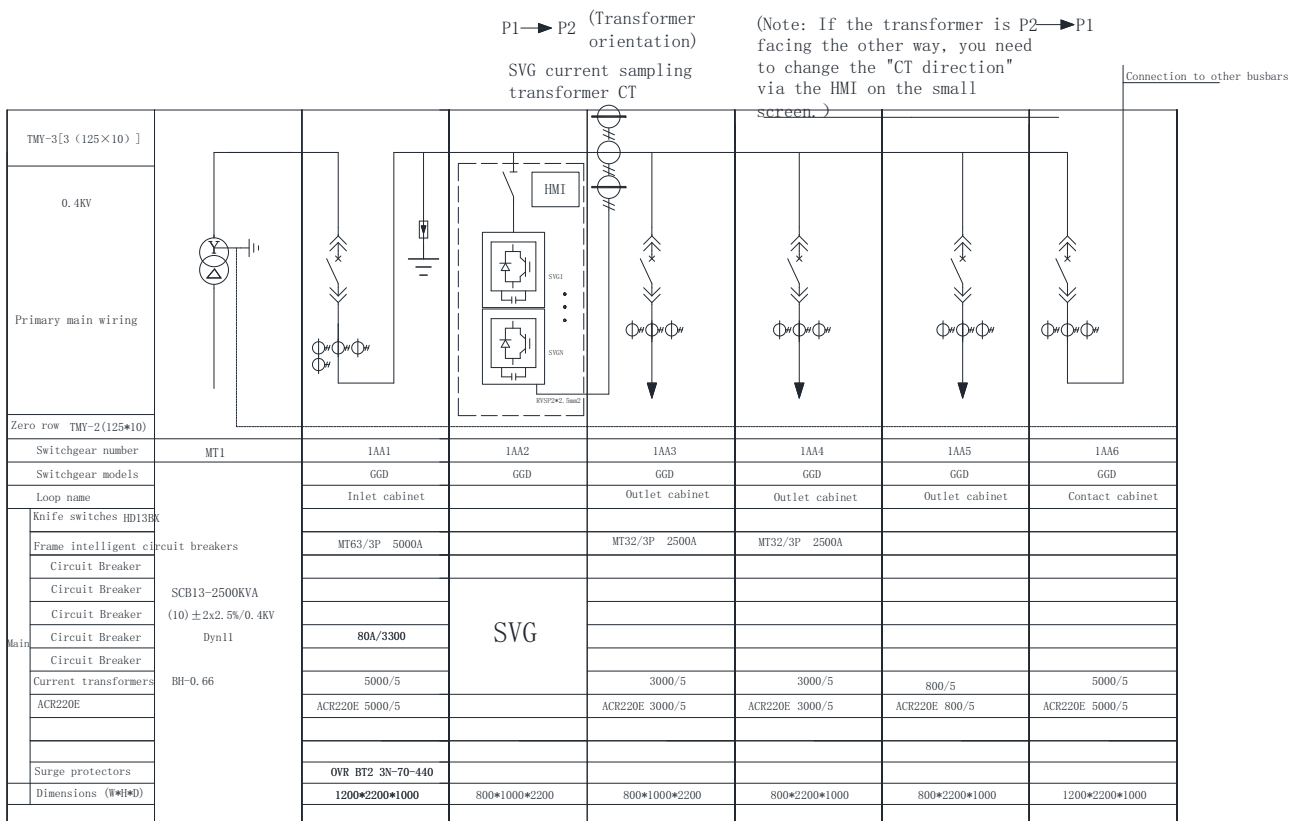

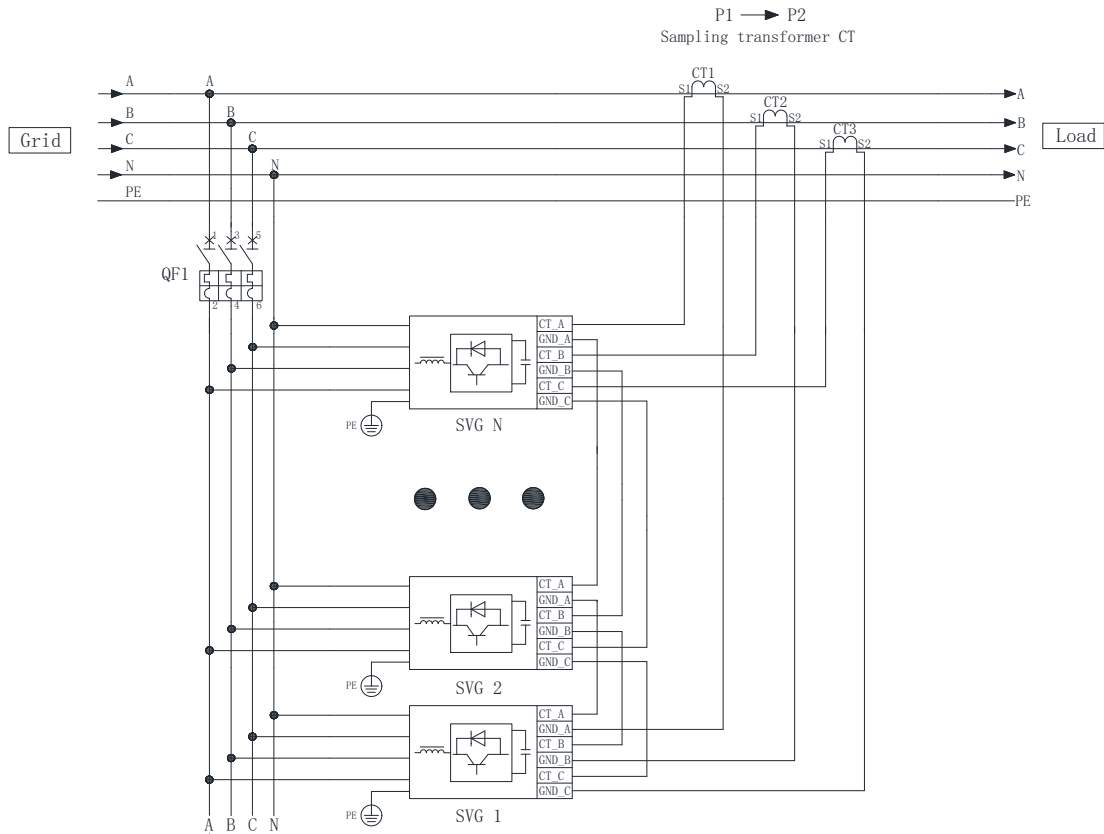

Figure 3-11 Combined distribution-CT load side sampling wiring diagram

(2) CT power supply side sampling

P1 → P2 (Transformer orientation) (Note: If the transformer is P2 → P1 facing the other way, you need to change the "CT direction" via the HMI on the small transformer CT screen.)

TMV-3 [3 (125×10)]							
0.4KV							
Primary main wiring							
Zero row TMV-2 (125×10)							
Switchgear number	MT1	1AA1	1AA2	1AA3	1AA4	1AA5	1AA6
Switchgear models		GGD	GGD	GGD	GGD	GGD	GGD
Loop name		Inlet cabinet		Outlet cabinet	Outlet cabinet	Outlet cabinet	Contact cabinet
Knife switches							
Frame intelligent circuit breakers		MT63/3P 5000A		MT32/3P 2500A	MT32/3P 2500A		
Circuit Breaker							
Circuit Breaker	SCB13-2500KVA						
Circuit Breaker	(10) ±2x2.5%/0.4KV						
Circuit Breaker	Dyn11						
Circuit Breaker							
Current transformers	BH-0.66						
ACR220E		5000/5		3000/5	3000/5	800/5	5000/5
		ACR220E 5000/5		ACR220E 3000/5	ACR220E 3000/5	ACR220E 800/5	ACR220E 5000/5
Surge protectors							
		OVR BT2 3N-70-440					
Dimensions (W*H*D)		1200*2200*1000	800*1000*2200	800*1000*2200	800*2200*1000	800*2200*1000	1200*2200*1000

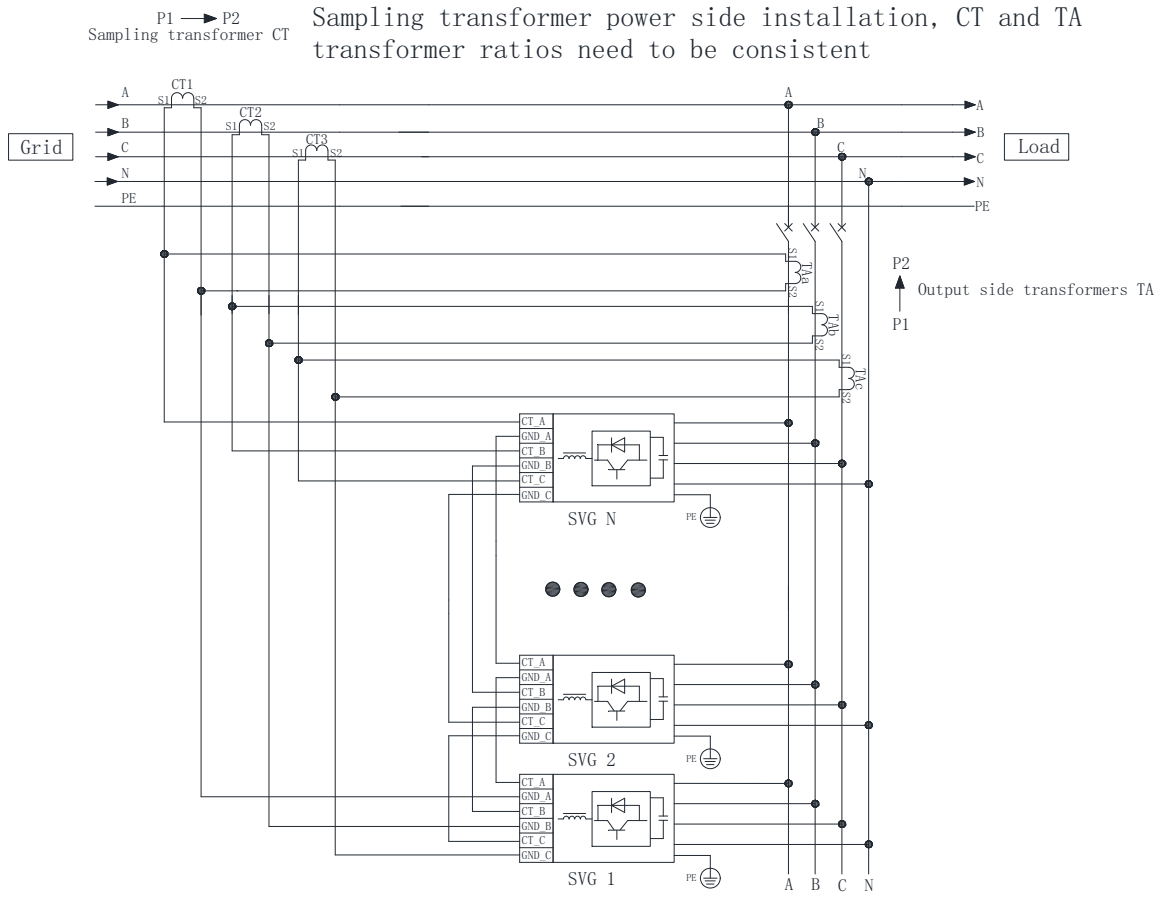

Figure 3-12 Combined power distribution-CT power supply side sampling wiring diagram

(3) Communication wiring

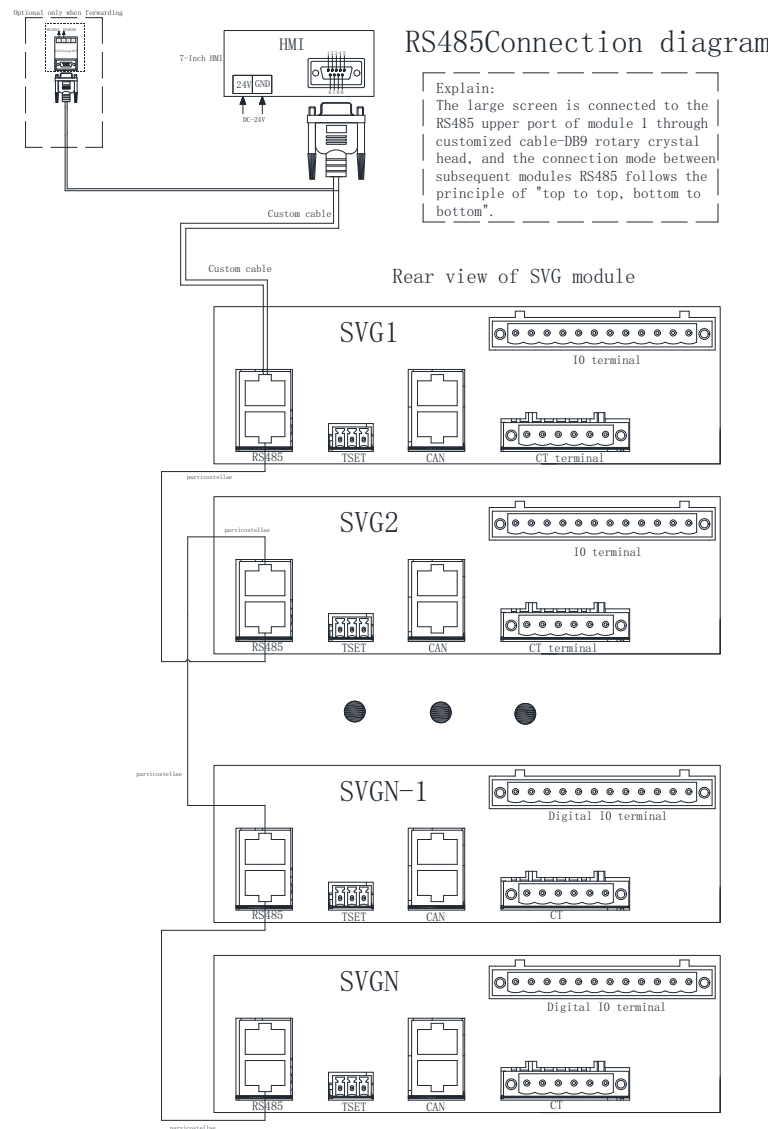
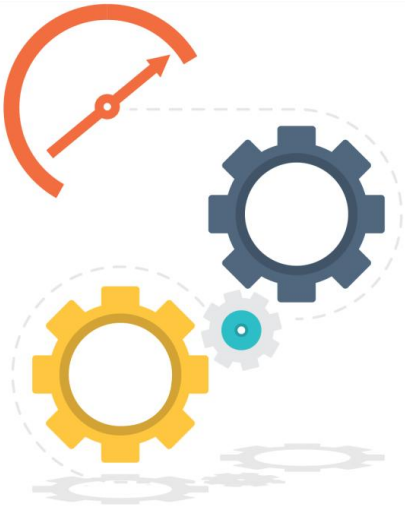

Figure 3-13 Integrated communication wiring diagram



attention to

- ◆ When connected with the machine, the external cabinet is generally equipped with a centralized monitoring screen, and the large screen and the module should be connected with DB9 special cable (our company), and connected to the monitoring port of the first module;
- ◆ Modules are connected with ordinary network cable, and the principle of "bottom to bottom, top to top" should be followed.



Chapter IV: Test

run of a single machine

4.1 Check the.....	34
4.2 Power-on to open for SVG.....	34.
4.3 The SVG is shut down for the.....	35
4.4 Manual / automatic run of the.....	36

Chapter IV. Test run of a single machine

4.1 Check again

Please check the following again before the first power on:

- (1) Whether the SVG equipment is firmly installed on the cabinet (wall) installation column;
- (2) A / B / C / N wiring is correct, whether there is leakage or mixed connection phenomenon;
- (3) A / B / C / N / PE wiring is firm, with hand shaking without displacement or loosening, and PE wiring should be firmly grounded;
- (4) The distance should be maintained, phase spacing not less than 15mm;
- (5) Use the multimeter to detect whether there is A short circuit between the equipment A, B, C and N;
- (6) Check whether the CT wiring is correct and whether the wiring at the terminal row corresponds one to one;
- (7) Check the installation position and installation situation of the current transformer;
- (8) Whether the disconnecting switch is installed correctly and is disconnected;
- (9) The SVG installation environment meets the contents described in Section 3.2;
- (10) Check whether the SVG phase order is consistent with that of the power grid, and the input voltage should be the positive phase order (ABCN).

4.2 Power on the SVG

After the above recheck, close the disconnecting switch between the power supply / grid and SVG, the module 4.3-inch LCD LCD (optional) or external 7-inch large screen is lit and enter the home page, the power / POWER indicator of the module is lit and always on. At this time, the module is in the "standby" state. Click "Login" to directly enter the data page and view the power grid voltage parameter data.

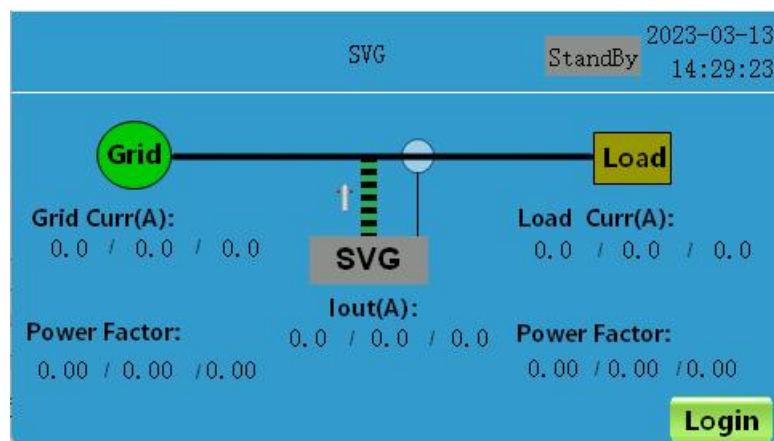

Figure 4-1 First-page interface

Go to the Settings page to see whether the CT change ratio and CT installation position is correct.



Figure 4-2 Setting up the operation interface

After ensuring the above error, enter the "switch machine" page, click "boot" (startup time is 30s, refer to section 6.5), and the module starts running. The Run / RUN indicator is on and constantly illuminated with the power / POWER indicator.

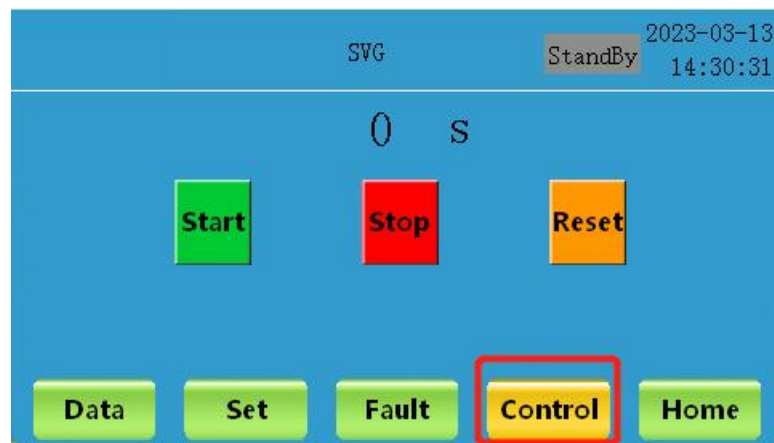

Figure 4-3 Operation interface of the switch machine

After the startup is successful, click "Data" and enter the "SVG" page to check whether the data of SVG is normal.

* **More 4.3-inch LCD display.**

4.3 SVG shutdown

SVG shutdown generally has two steps: shutdown and power off.

(1) Shutdown

That is, through the module 4.3 "LCD LCD screen (optional) or external 7" large screen, click "shutdown" to enter the standby state, the running / RUN indicator is off, but the power supply / POWER indicator is always on. This method only makes the module into the low power standby state, and the system bus, auxiliary power supply and main circuit terminal are still charged.

(2) Power failure

After the equipment is shut down and enters the standby state, then disconnect the isolation switch between the SVG equipment and the power supply / grid, so that the SVG equipment can stop running and completely power off. When the module needs to be wired or maintained, it should be under power off and

shutdown.

*** Do not directly power off the equipment in operation, which will cause some damage to the equipment!**

4.4 Manual / automatic operation

SVG devices are started in default manual mode. The manual mode should manually log in the user interface and click on. The automatic mode can automatically turn up and run after the module is powered on. Users can switch to automatic mode in standby state according to actual requirements. Please refer to Section 6.6 for specific operation.

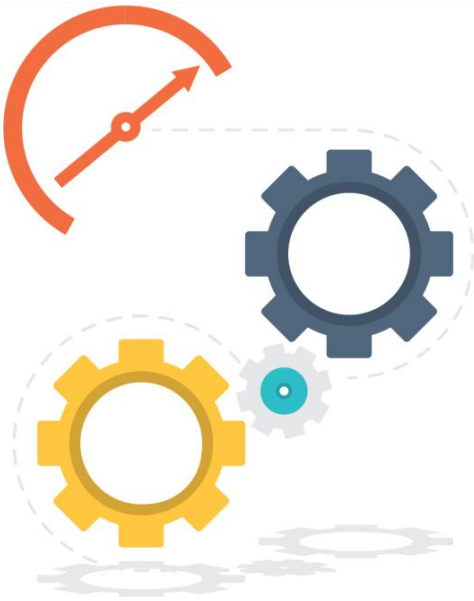

Chapter V Trial operation

5.1 Check the.....	38
5.2 Power on the SVG.....	38
5.3 SVG shutdown.....	39
5.4 Manual / automatic run of the.....	40

Chapter V. Trial operation

The installation of the parallel module is generally equipped with a 7-inch large cabinet screen. For operation details, please refer to the 7-inch large screen user manual. No detailed explanation is given here.

5.1 Check again

Please check the module one by one before the first power-on, including the installation environment, installation position, wiring, etc. Please refer to section 4.1. In addition, it is necessary to check whether the communication wiring between the 7-inch large screen and the first module is correct, whether the positive and negative poles of the large screen power cord are mixed, and whether the wiring between the parallel modules follows the principle of "top up, bottom down".

5.2 Power on the SVG

After the above inspection, the disconnecting switch between city and SVG is closed, the 7-inch screen and the 4.3-inch LCD screen (optional) are lit, the power supply / POWER indicator of the module is lit and always on, check whether the power supply / POWER indicator of each parallel module is lit, and the module is in the "standby" state.

Log in to senior users of 7-inch large screen, enter the home page, and check whether the data parameters such as voltage and current on the power grid side, output side and load side of each parallel module are normal;

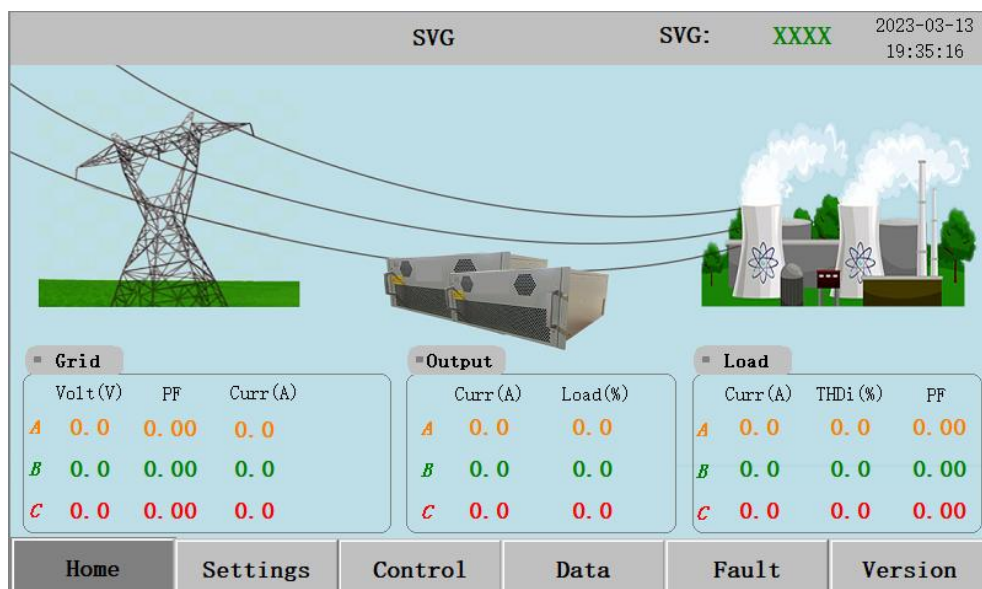

Figure 5-1 First interface of the large screen

Then enter the setting page to see whether the CT change ratio, CT position, CT direction, operation mode, parallel capacity and other setting parameters are correct. At this time, through the large screen to switch the parallel module, observe whether the data of each module is normal and consistent with the setting parameters. If this fails, check the wiring and modify the parameters through the large screen operation (operate under the guidance of the engineer).

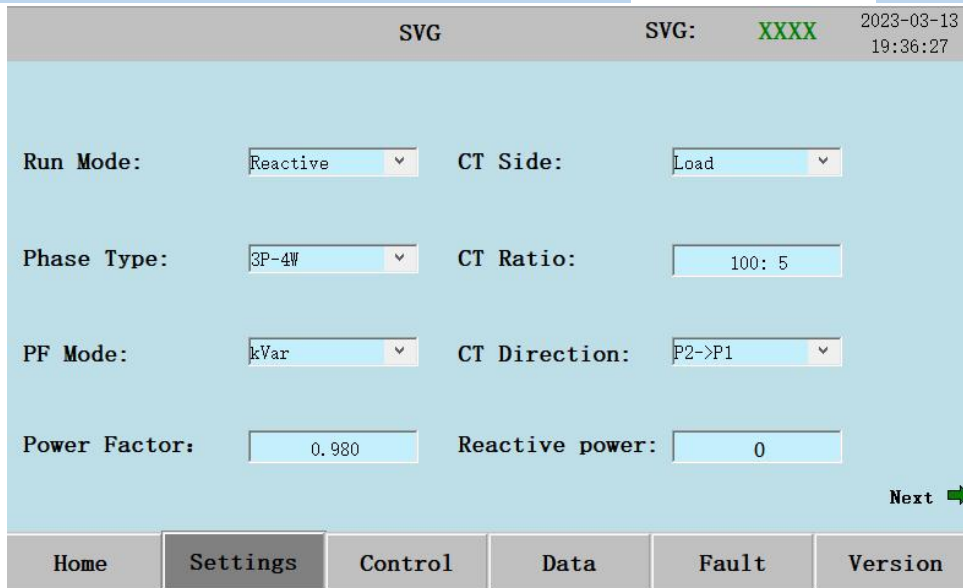

Figure 5-2 Large screen

After ensuring that the parameters are correct, enter the "Control" page, click "boot" (the startup time is 30s), and the module starts running. Each parallel module running / RUN indicator is on and on together with the power / POWER indicator. At this time, check whether each module running / RUN indicator is on. If a module with the indicator is not lit, check whether the connected communication line is connected correctly.

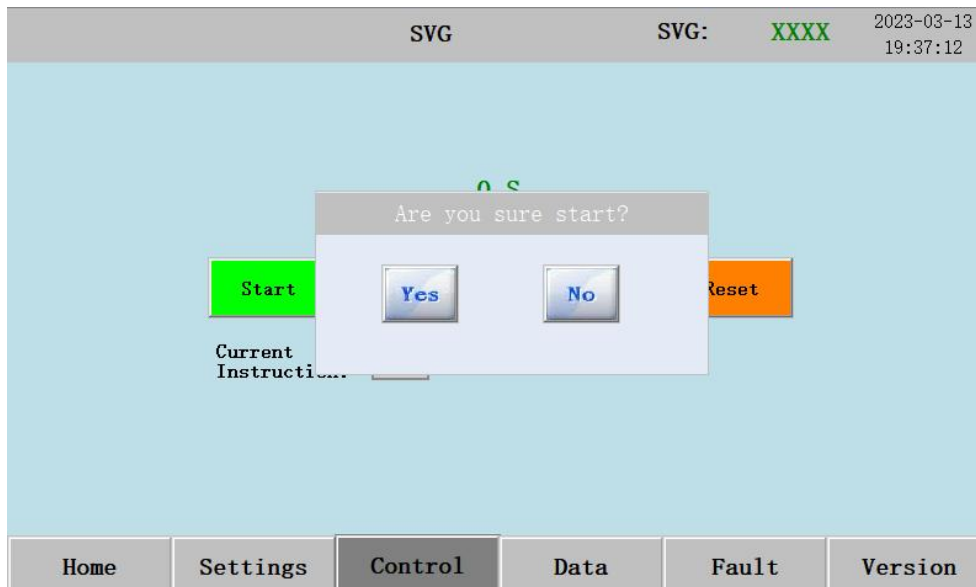

Figure 5-3 Large-screen control interface

After the startup is successful, click "Data" to check whether the "basic", "power" and "harmonics" are normal.

5.3 SVG shutdown

The parallel SVG module shutdown generally has two steps: shutdown and power off.

(1) Shutdown

That is, through the 7-inch screen of the module, enter the "switch" page, click "Shutdown", all the parallel modules enter the standby state, the running / RUN indicator is off but the power / POWER

indicator is still on. This method only makes the module into the low power standby state, and the system bus, auxiliary power supply and main circuit terminal are still charged.

(2) Power failure

After the equipment is shut down and enters the standby state, then disconnect the isolation switch between each SVG equipment and the power supply / power grid, so that the SVG equipment can stop running and completely power off. When the module needs to be wired or maintained, it should be in a state of power shutdown.

*** Do not directly power off the equipment in operation, which will cause some damage to the equipment!**

5.4 Manual / automatic operation

SVG devices are started in default manual mode. The manual mode should manually log in the user interface and click on. The automatic mode can automatically turn up and run after the module is powered on. Users can switch to automatic mode in standby condition according to actual requirements. Please refer to the 7-inch large screen user manual without additional explanation here.



Chapter VI A 4.3-inch screen menu

6.1 LCD open-Home page.....	42
6.2 Data page.....	43
6.3 Set up the page.....	46
6.4 Fault surface	47
6.5 switch page.....	48
6.6 Operation setup example.....	49

Chapter VI .4.3-inch screen menu

The front panel of the module will have a 4.3-inch LCD LCD (optional) that provides a user-friendly user interface.

- (1) Users can view the status and information of the power grid, load and SVG module through the 4.3-inch screen;
- (2) Users can conduct all operation commands in the menu of the module through the menu button provided on the page;
- (3) It is beneficial to monitor, view and eliminate the SVG module faults;
- (4) The SVG system version and the monitoring software system version can be displayed;
- (5) Click the "Login" key to enter the user interface, without entering the password, convenient and fast;
- (6) The screen display page can be customized according to the requirements, can display logo, special model, name, change background, etc.

6.1 LCD open-home page

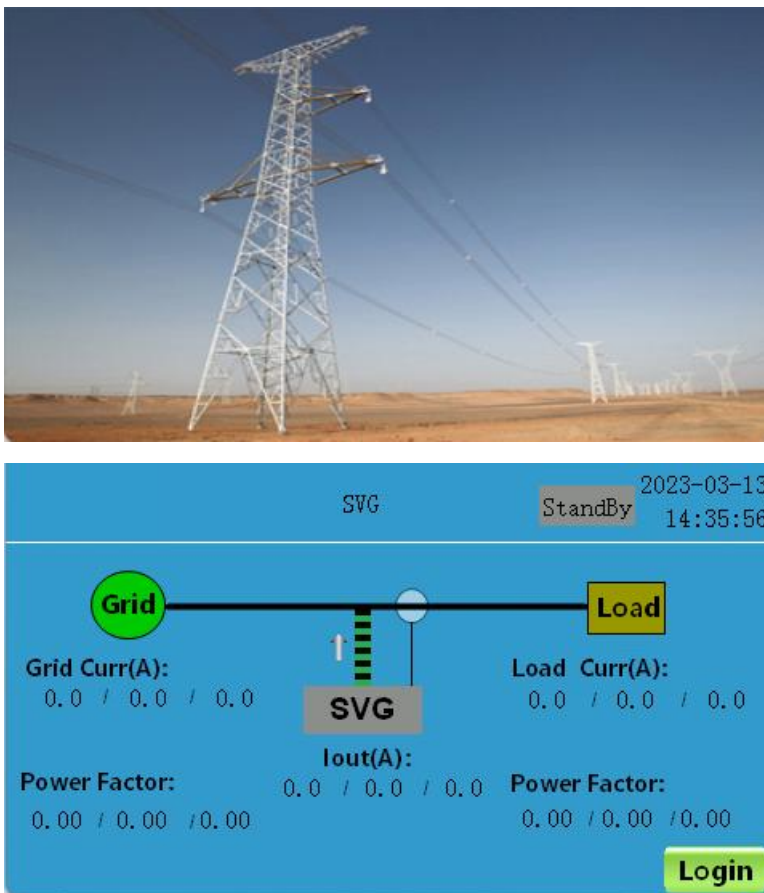
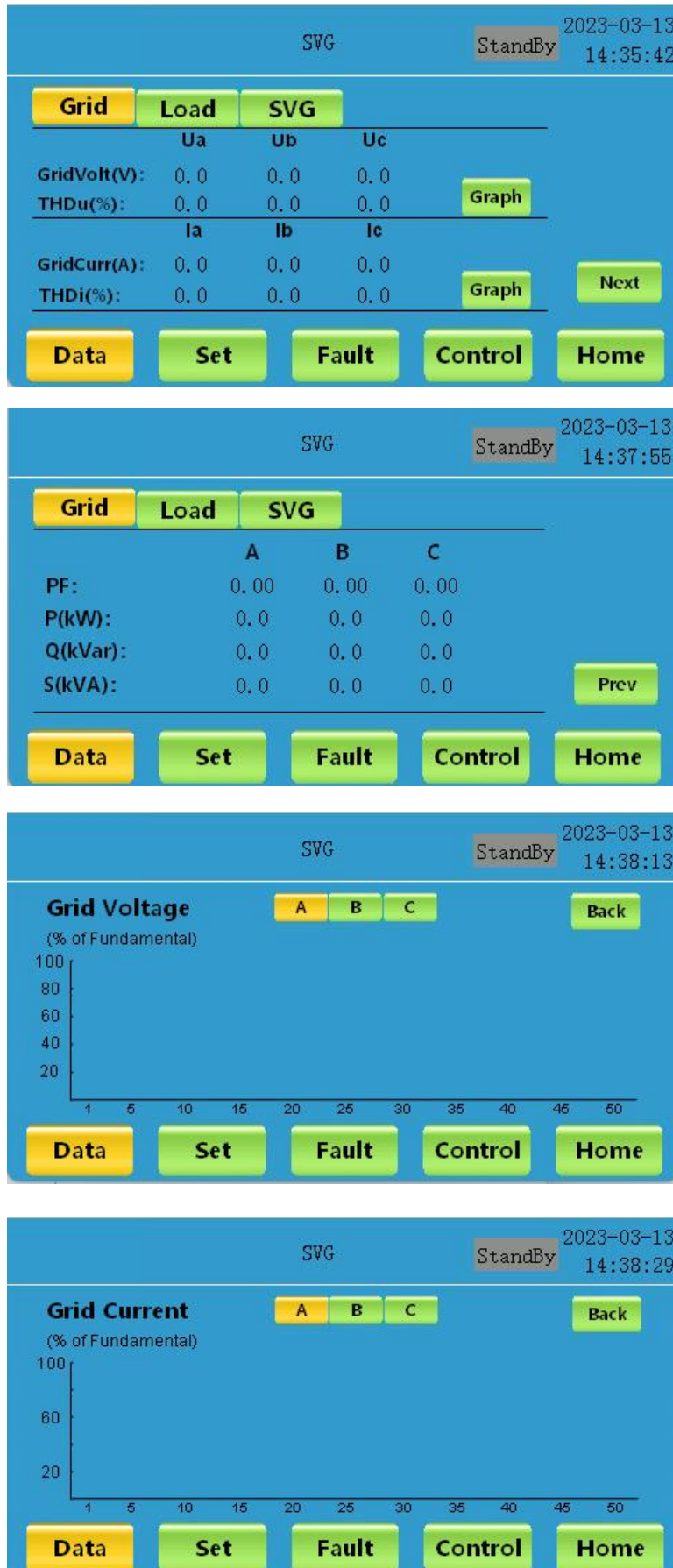

Figure 6-1 Home page

- ◆ After the screen is powered on, the screen will automatically light up, and the home page will automatically enter the home after the boot page, without secondary operation;
- ◆ The data of power grid, load and SVG current can be viewed on the home page;
- ◆ The model and status of the SVG device (standby / running) can be viewed at any interface on the screen.

6.2 Data page

6.2.1 Power grid data



The power grid data page contains two pages:

- ◆ On the first page, you can view the data of the grid: grid voltage value, grid voltage histogram and voltage distortion rate THDu, grid current, grid current histogram and current distortion rate THDi;
- ◆ On the second page, you can view the power factors, active power, reactive power, apparent power and other values of the power grid.

Figure 6-2 Data page-Power Grid

6.2.2 Load data

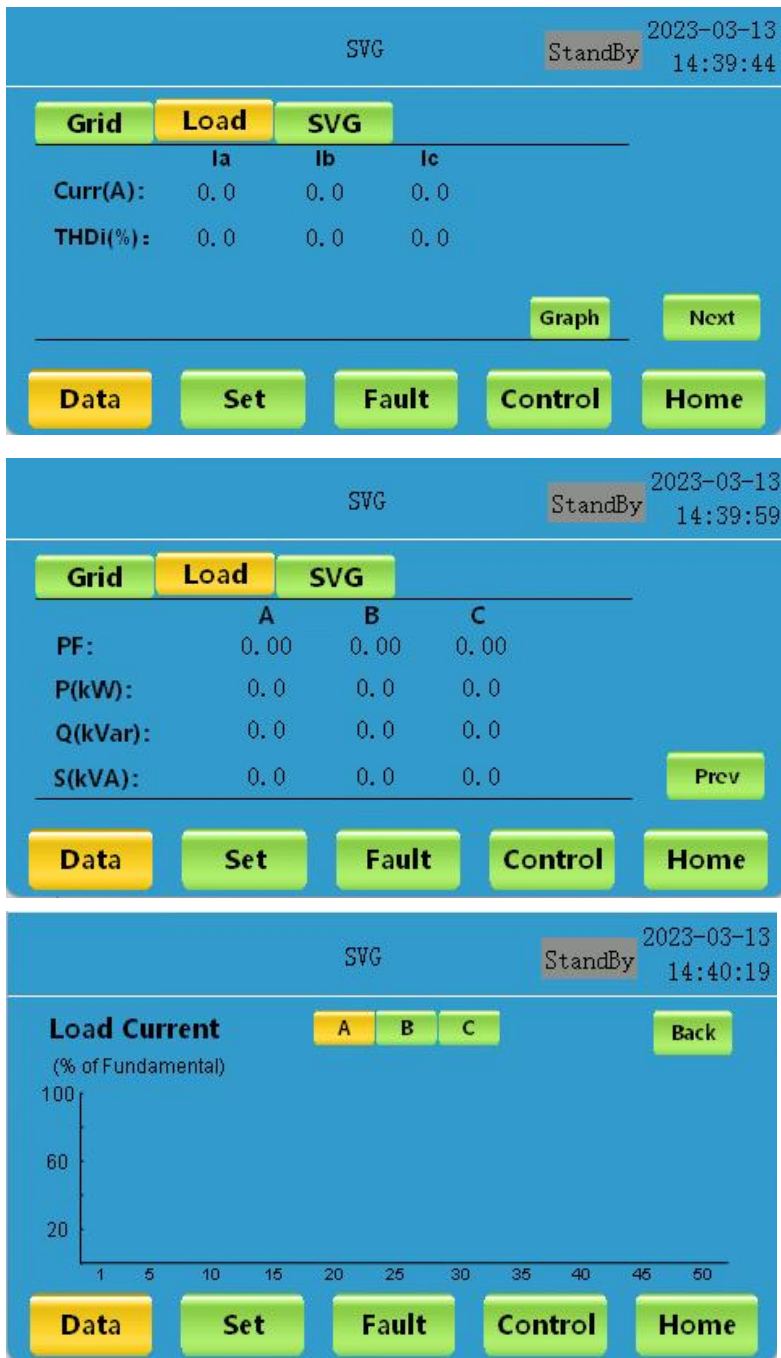

Figure 6-3 Data page-Load

The load data page contains two pages:

- ◆ On the first page, the load three-phase current, the current distortion rate THDi and the load current can be checked in the bar chart;
- ◆ On the second page, you can view the power factors, active power, reactive power, and apparent power of the load in three phases.

6.2.3 SVG data



Figure 6-4 Data Page-SVG

The SVG data page contains two pages:

- ◆ On the first page, you can view the data of the SVG equipment: output current, bus voltage, contactor status, and system temperature;
- ◆ On the second page, you can view the model, main DSP version, secondary DSP version, FPG A version, and HMI version of the SVG device.

6.3 Setup page

The Settings page can be entered through the "Settings" button on the screen. There are five pages.

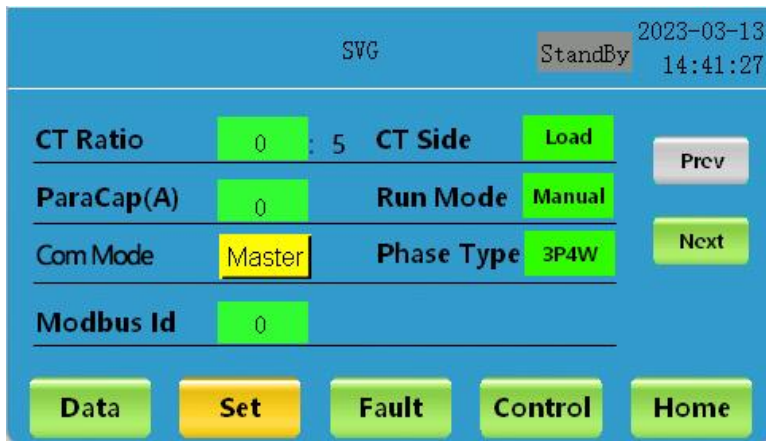

- ◆ On the first page, you can view the CT ratio, CT position, parallel capacity, startup mode, primary mode, connection mode, connection mode and ModBus address;



- ◆ On the second page, you can view the data of power grid overvoltage point, power grid undervoltage point, power grid overfrequency point, power grid overfrequency point, zero line overcurrent point, power grid overcurrent point, monitoring address, resonance overcurrent point and so on.



Pages 3 and 4 are for the harmonic compensation settings:

- ◆ On the third page can open and close 1~49 harmonic compensation (odd times);



- ◆ On the fourth page, you can open and close 2~50 harmonic compensation (even times).



Figure 6-5 Settings page

- ◆ On the fifth page, you can view the data of power grid phase sequence, power factor, allowable phase sequence, reactive power given mode, serial port 1 wave rate, serial port 3 wave rate, reactive power, parallel number and other data;
- ◆ Curing parameters: save the parameters for the settings.

6.4 Fault page



Figure 6-6 Fault page

The fault page can be accessed through the "fault key on the screen," which has five pages.

- ◆ In the first three pages, you can view the EPO fault, IGBT fault, power grid fault, pre-charging bus fault, communication fault.... Whether it occurs, so as to determine whether the machine is operating normally;
- ◆ When the fault / F A ULT A indicator is red, look at the fault page or record to locate the fault type more quickly.

- ◆ Click the "History" key to enter the fourth page, where you can view the SVG device history fault information, including date, time and fault information;
- ◆ Click the "Clear record" key to delete the fault information record.

6.5 Switch the machine page

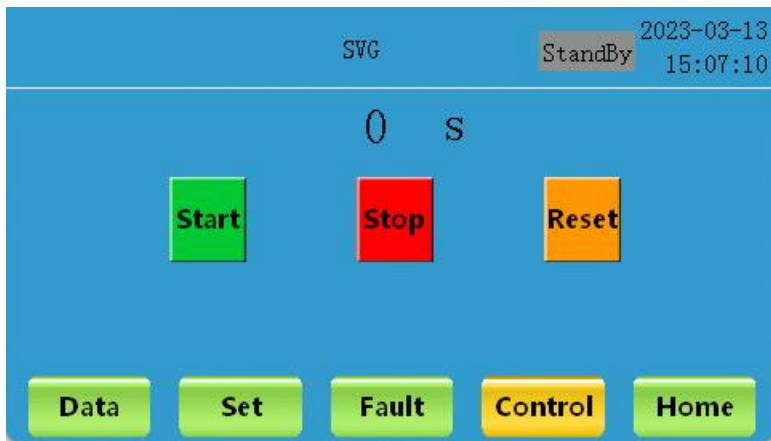



Figure 6-7 Switch machine page

- ◆ Click the "boot" button, the number at the top of the screen from 0s 30s, the boot time ends, the SVG device issued a gentle "bang" sound, representing the machine has been started successfully, the device entered the running state;
- ◆ Click the "Shutdown" button, and the SVG device enters the low-power standby state;
- ◆ Click the "reset" button to eliminate the fault.

6.6 Example of operation settings

The user can perform all the operation commands in the module on the menu through the menu button provided by the page, setting the operation in this example part.

 pay attention to	<ul style="list-style-type: none"> ◆ All the setting operations must be carried out in the standby state, after the setting is completed, the parameters need to be solidified, so that the setting result will take effect; ◆ All the parameters have been set when leaving the factory. If the set parameters need to be modified due to the actual situation on site, please contact the professional technical personnel in time and operate under the guidance of the professional technical personnel. If any equipment failure or damage, the company will not be responsible for!
--	---

6.6.1 Set the CT change ratio

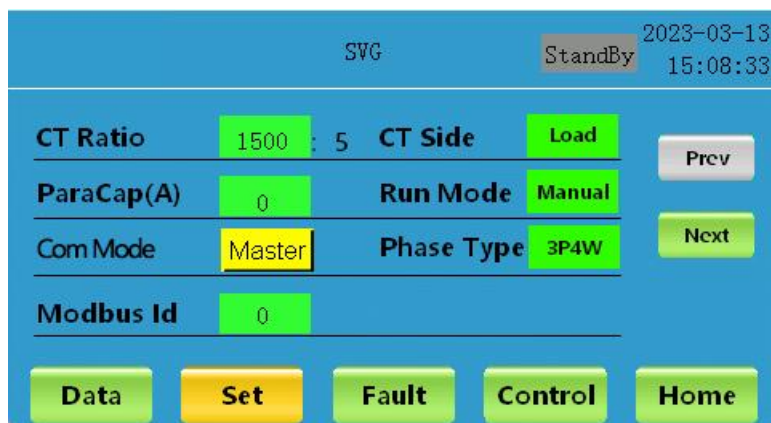
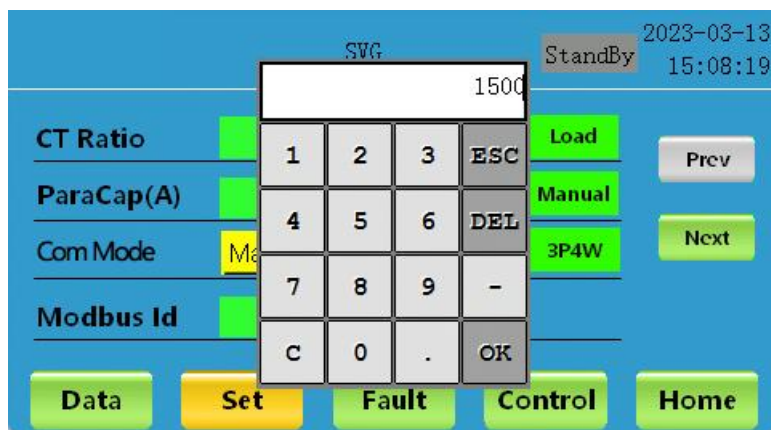
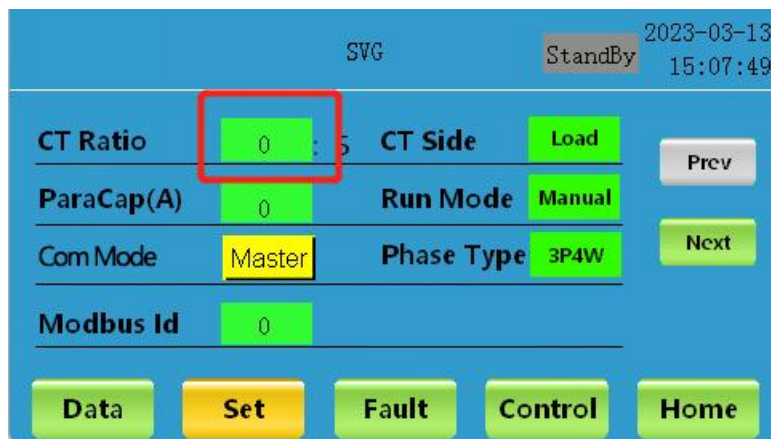

- ◆ Find the "CT ratio" in the setting page, click the green button to call out the keyboard, input the correct and reasonable ratio value according to the actual situation on the site, and click "OK" to confirm.

Figure 6-8 Setting the CT change ratio

6.6.2 Set the CT position

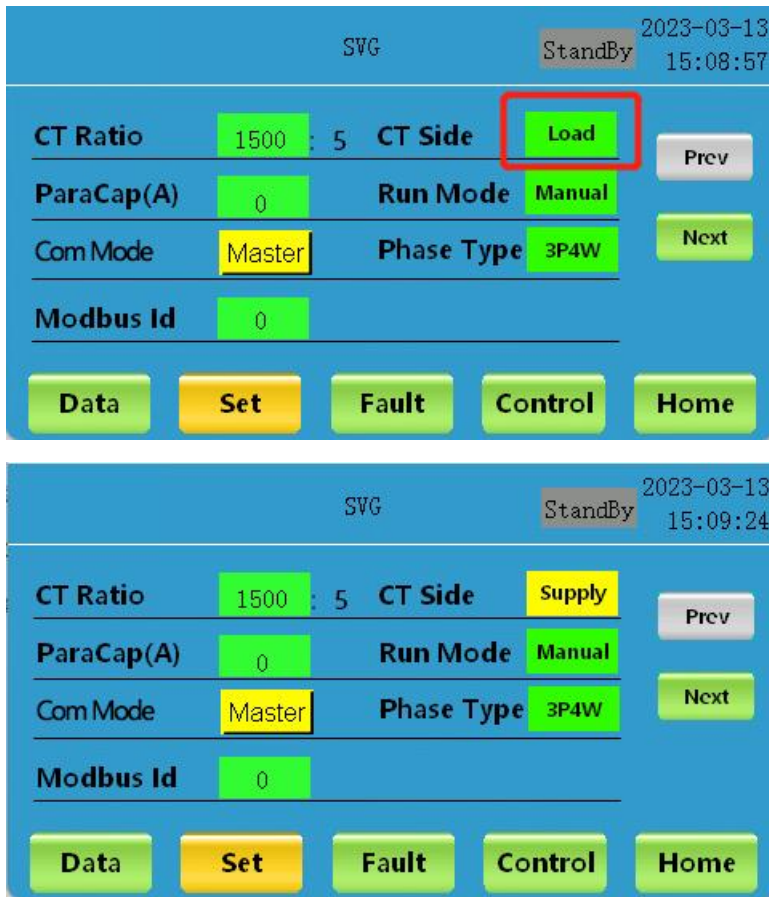

Figure 6-9 Setting the CT position

6.6.3 Set the startup mode

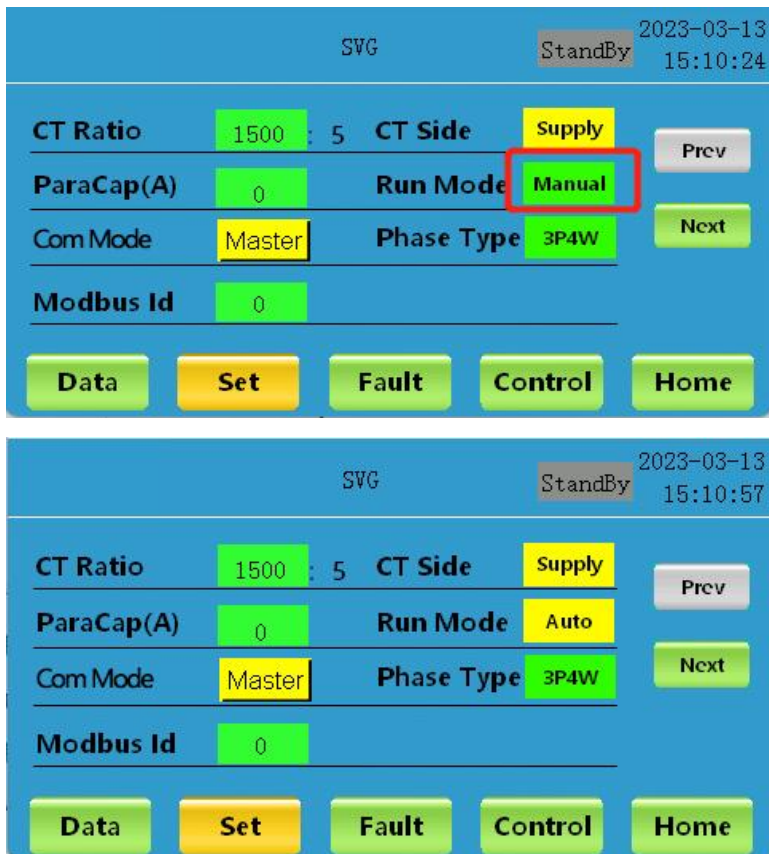

Figure 6-10 Setting the start-up mode

- ◆ CT location factory setting default "load side";
- ◆ If the CT on the site is installed on the power side, the CT position should be switched from the "load side" to the "power side";

- ◆ After the module is powered on in manual mode, it shall be operated manually on;
- ◆ In automatic mode, after the module is powered on, it can automatically turn on for operation, without secondary operation;
- ◆ Start mode factory default setting is manual mode;
- ◆ According to the actual requirements in the equipment standby state click to switch to automatic mode.

6.6.4 Reactive power setting

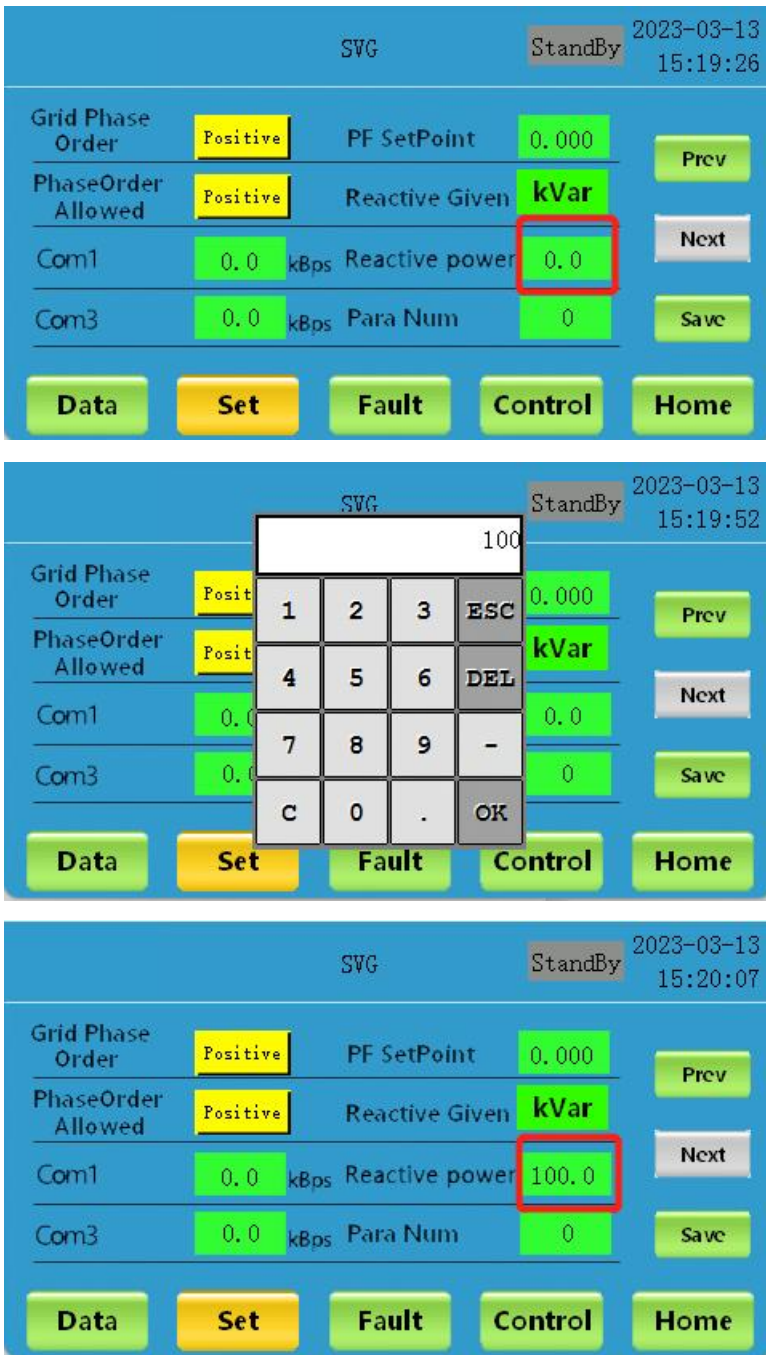

Figure 6-11 Setting up reactive power compensation

- ◆ The given mode of SVG equipment is set to kVar;
- ◆ Then input the reactive power value in the reactive power column.

6.6.5 Set the phase sequence

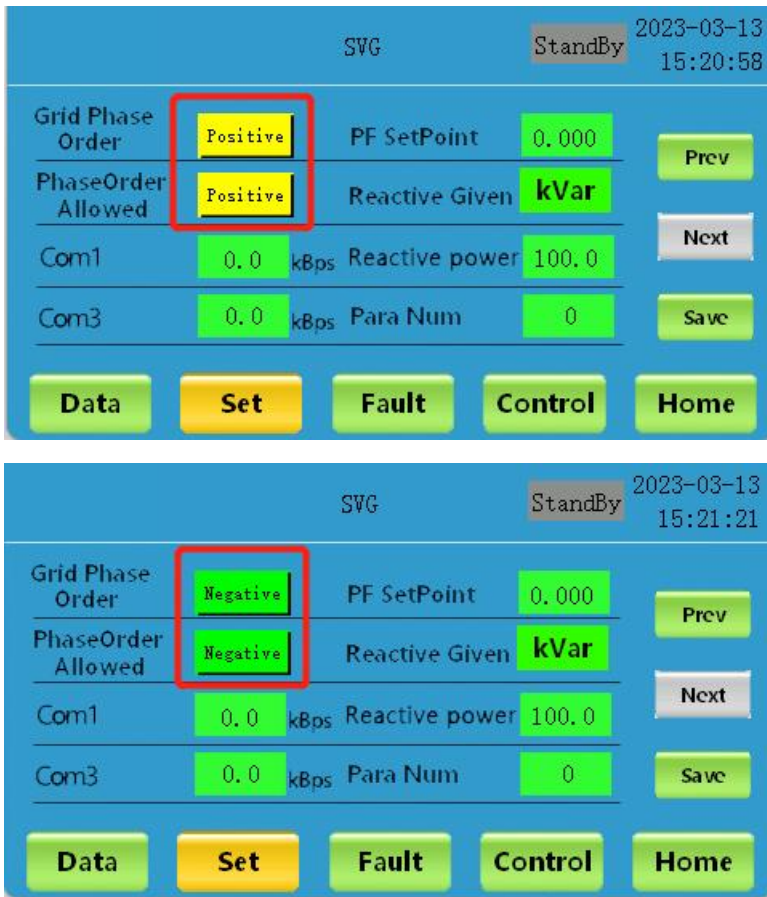

Figure 6-12 Setting the phase sequence of the grid

- ◆ SVG equipment can automatically identify the power grid phase sequence as "positive order" or "negative order", allowing the phase sequence to be set to positive order by default. When the phase sequence of the power grid is displayed as "negative order", the allowed phase sequence needs to be manually switched to "negative order".



Chapter VII Cabinet 7-inch HMI

Chapter VII. Cabinet 7-inch HMI

7.1 7- inch HMI Presentation

The LCD 7-inch HMI is installed on the front side of the reactive power compensation cabinet door and comes in two different sizes. Users can monitor the reactive power compensation cabinet through HMI, read and set the modified SVG parameter data, which is an optional item. For detailed information about the 7-inch HMI!

The two different opening sizes of 7-inch HMI are 215 * 152mm and 192 * 138mm respectively. Generally, 215 * 152mm hole size screen is selected by default. If you need to choose 192 * 138mm hole size screen, please note in advance.

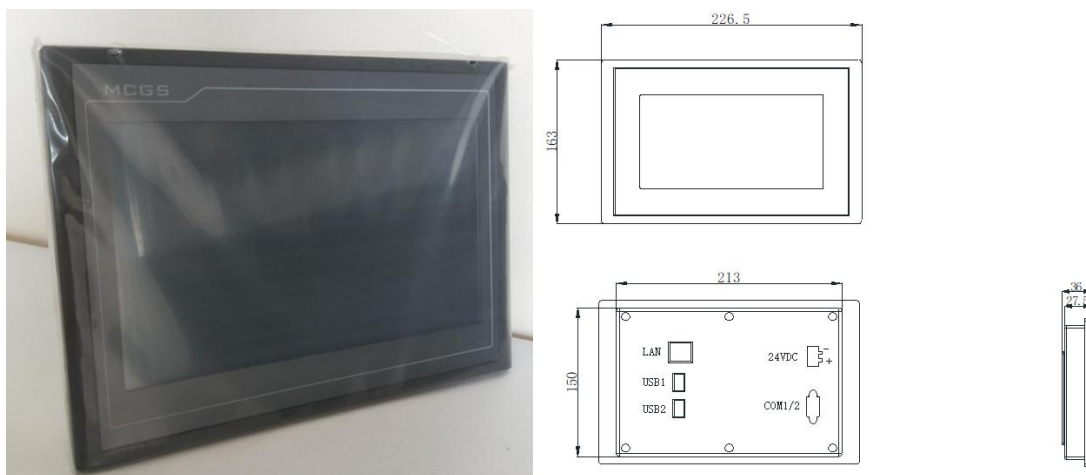
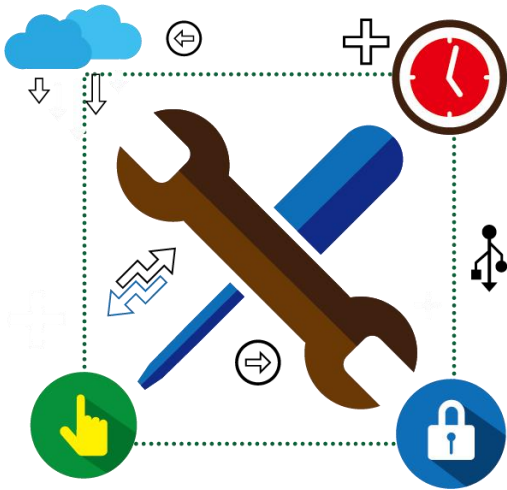

Figure 7-1 215 * 152 Open large screen

product features		peripheral interface	
LCD	7 Inch TFT	serial interface	COM1 (RS232), COM2 (RS485), scalable (COM3, COM4)
Backlight	LED	USB joggle	1 Main 1 from
input voltage	DC: 24V±20%	C kVar N Interface	open end
power rating	5W	Ethernet port	nonsupport
attestation		ambient condition	
product certification	CE/FCC	Storage temperature	-10~60°C
levels of protection	The IP65 front panel	working temperature	0~45°C
electromagnetic	Industrial level 3	Working humidity	5%~95%

compatibility			
	size of product		
	Case material	Industrial plastic	
	Panel size	226.5*163 (mm)	
	Open hole size	215*152 (mm)	

*** In addition, we can provide a large 10-inch HMI screen, with the recommended cabinet opening size of 261 * 180mm.**



Chapter VIII Maintenance and Maintenance

8.1 Note the before maintenance.....	57
8.2 Daily maintenance content and cycle.....	57
8.3 Complete, maintenance step.....	58

Chapter VIII Maintenance and Maintenance

In order to ensure the normal and safe operation of the SVG equipment, we recommend the regular maintenance of the equipment.

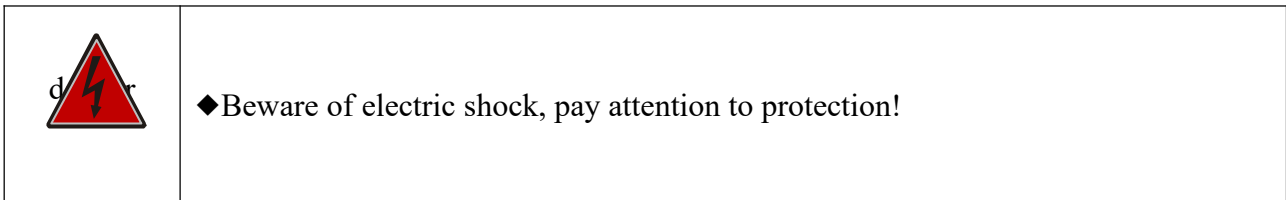

8.1 Attention before maintenance

- (1) SVG equipment operates with strong electricity, for safety, the maintenance personnel shall not touch any part of the equipment during the equipment operation;
- (2) Due to the large number of capacitances of the SVG equipment bus, the maintenance work must be carried out after 15 minutes of power failure;
- (3) After the power supply is disconnected, a warning sign should be set at the disconnected place to prevent someone from being on in the maintenance process;
- (4) In order to avoid accidental risks, the maintenance personnel should wear insulation equipment during the maintenance process;
- (5) Personnel with professional and technical qualifications are required to maintain the SVG equipment.

8.2 Content and cycle of daily maintenance

Maintenance project	Maintain the content	Recommended time
routine inspection	Need to SVG equipment Input, output voltage and current and operating state for real-time monitoring, observe whether it is within the normal range;	Daily
	Check whether the air inlet and outlet are unobstructed;	
	Read the internal temperature of the SVG equipment and see if it is in the normal range.	
Status check	check up SVG equipment Whether the appearance is damaged or rusty;	half a month
	hear SVG equipment Whether there is an abnormal sound when running, smell whether there is a peculiar smell;	
	Check whether the ambient humidity, temperature, dust and ventilation conditions around the equipment meet the requirements.	
Cable inspection	Check whether the cable and terminals are damaged;	trimester
	Whether the main circuit wiring, grounding wire and communication wiring are reliably connected;	

	Check whether there are signs of aging and burning at the wiring bolts, and shake it by hand to confirm whether it is tightened.	
--	--	--

8.3 Complete maintenance steps

Step 1: Check the surrounding environment

- (1) Test the temperature and humidity of the current environment with professional instruments to ensure that it is within the normal range;
- (2) Remove the debris around the module and keep it dry.

Step 2: Shut off

- (1) Disconnect the disconnecting switch, and SVG power off;
- (2) Wait for at least 15 minutes before the capacitor in the module is fully discharged.

Step 3: Clean the equipment

- (1) Check whether the surface of the equipment is damaged or missing;
- (2) Visual check whether the cable is deformed or damaged;
- (3) Clean up the dust and debris on the surface of the equipment, and pay attention to the cleaning in the air outlet for foreign body blockage.

Step 4: Check the disconnecting switch

- (1) Check whether the isolating switch is aging and damaged.

Step 5: Check the mechanical installation / electrical connection

- (1) Check whether the installation screws at all mechanical connections are firm, and clean up the dust above;
- (2) Check whether the electrical wiring is firm, and the cable can be properly strengthened or replaced.

Step 6: Other abnormalities

- (1) For example, if the internal cable is damaged, please contact the technical personnel of the manufacturer in time.

Step 7: Restart the device

- (1) Restore all cable connections and check;
- (2) Close the isolation switch and start the equipment;

- (3) Check the parameters;
- (4) Start-up and operation.



ChapterIX. Common fault handling

Chapter IX. Common fault handling

9.1 Fault List

order number	Fault name	processing method
1	EPO hitch	Check whether the emergency stop switch button is pressed, reset the button switch and click the reset switch on the small screen; if not solved, please contact the professional technicians of the manufacturer!
2	The IGBT hardware overflows	Reset or restart boot, If not solved, please contact the professional and technical personnel of the manufacturer!
3	Bus hardware overpressure	Click the small screen data interface to view the SVG data bus voltage V, the normal module standby bus voltage is about 650, if beyond the range, please contact the manufacturer professional technicians!
4	Overflow of module hardware	Check whether the CT installation direction is consistent with the setting, and whether the CT secondary wiring is reverse. If not solved, please contact the professional and technical personnel of the manufacturer!
5	Auxiliary power failure	This fault occurs, please contact the professional technicians of the manufacturer to solve it!
6	Fan fault	Check whether the fan is running normally, if the fan is not replaced, the normal operation can be reset before starting. If not solved, please contact the professional technicians of the manufacturer!
7	Single board connection failure	Click to reset or restart boot, If not solved, please contact the professional and technical personnel of the manufacturer!
8	Melt damage	Click to reset or restart boot, If not solved, please contact the professional and technical personnel of the manufacturer!
9	The power module is too warm	Check whether the ambient temperature is too high, and whether the inlet and outlet of the system are smooth. If everything is normal, it can be reset and then boot. If not solved, please contact the professional and technical personnel of the manufacturer!

10	Voltage A / AB overvoltage	Confirm whether the input voltage is normal, if not solved, please contact the manufacturer professional technician!
11	Voltage B / BC overvoltage	Confirm whether the input voltage is normal, if not solved, please contact the manufacturer professional technician!
12	Voltage A / AC overvoltage	Confirm whether the input voltage is normal, if not solved, please contact the manufacturer professional technician!
13	Voltage A / AB undervoltage	Confirm whether the input voltage is normal, if not solved, please contact the manufacturer professional technician!
14	Voltage B / BC undervoltage	Confirm whether the input voltage is normal, if not solved, please contact the manufacturer professional technician!
15	Voltage C / CA undervoltage	Confirm whether the input voltage is normal, if not solved, please contact the manufacturer professional technician!
16	Power grid overfrequency	Confirm whether the input voltage frequency is in the range of 40.5~62.5Hz. If this is the system misalarm, please contact the professional technical personnel of the manufacturer.
17	Power grid underfrequency	Confirm whether the input voltage frequency is in the range of 40.5~62.5Hz. If this is the system misalarm, please contact the professional technical personnel of the manufacturer.
18	Power grid phase inversion	Check whether the input power grid phase sequence and the allowable phase sequence are correct, if not solved, please contact the professional and technical personnel of the manufacturer!
19	A phase flow	Reduce the input current value of the power grid, if not solved, please contact the professional technicians of the manufacturer!
20	B phase flow	Reduce the input current value of the power grid, if not solved, please contact the professional technicians of the manufacturer!
21	C phase flow	Reduce the input current value of the power grid, if not solved, please contact the professional technicians of the manufacturer!
22	Pre-charging bus overvoltage	Click reset shutdown, disconnect the circuit and adjust the bus for power, If not solved, please contact the professional and technical

		personnel of the manufacturer!
23	Pre-charging bus bar is undervoltage	Click reset shutdown, disconnect the circuit and adjust the bus for power, If not solved, please contact the professional and technical personnel of the manufacturer!
24	Uncontrolled rectified bus undervoltage	Click the reset shutdown, disconnect the circuit and restart the circuit switch, If not solved, please contact the professional and technical personnel of the manufacturer!
25	Run the bus overpressure	Confirm whether the bus voltage is normal, if not solved, please contact the professional and technical personnel of the manufacturer!
26	Running bus underpressure	Confirm whether the bus voltage is normal, if not solved, please contact the professional and technical personnel of the manufacturer!
27	Plus and minus bus line imbalance	Check whether the N line is connected, if not solved, please contact the professional technicians of the manufacturer!
28	Background communication protocol error	Check whether the connection between the module and the large screen is normal. If not, please contact the professional technical personnel of the manufacturer!
29	EEPROM hitch	Click reset restart boot, if not solved, please contact the manufacturer professional and technical personnel!
30	Auxiliary DSP failure	Click reset restart boot, if not solved, please contact the manufacturer professional and technical personnel!
31	Synchronous phase locking between DSP s	Click reset restart boot, if not solved, please contact the manufacturer professional and technical personnel!
32	System resonance	Click reset restart boot, if not solved, please contact the manufacturer professional and technical personnel!
33	The module does not communicate with the large screen	Check whether the communication line is connected, whether the positive and negative electrode of the 24V power line is connected, and whether the wiring screw is tightened. If not solved, please contact the professional and technical personnel of the manufacturer!

*** Only common faults and response methods are listed here. In case of other unknown faults, please contact professional manufacturers in time!**

Appendix:

1. 400V-100kVar / 150kVar and 690V-120kVar appearance

The 400V-100kVar / 150kVar and 120kVar and 690V-120 kV ar modules have the same appearance style except for different dimensions.

(1) Rack type

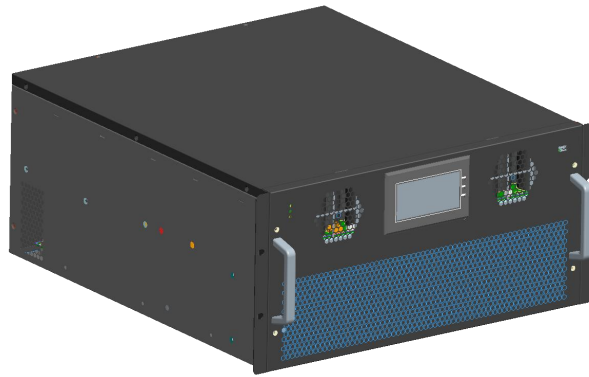

Appendix Figure 1-1 Rack Mounted

(2) Wall hanging type

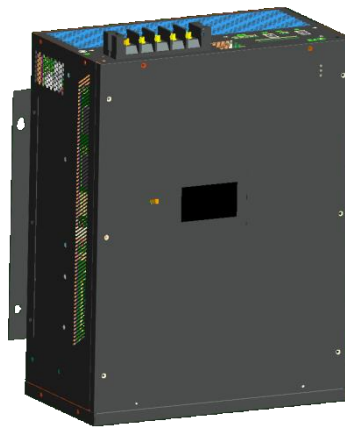

Appendix Figure 1-2 Wall Mounted

(3) Vertical

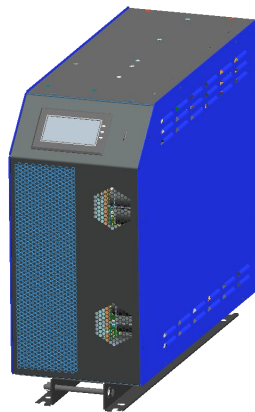

Appendix Figure 1-3 Vertical

2. Background forwarding instructions and interface definition

The background forwarding function is a function that sends the SVG and device data collected on the large screen or directly sends SVG device data to other receiving devices through customized cables. At present, only "one-to-one" forwarding is supported, that is, the data sent by a large screen or an SVG can only be received by one device (upper machine, background terminal, etc.).

(1) Large-screen forwarding

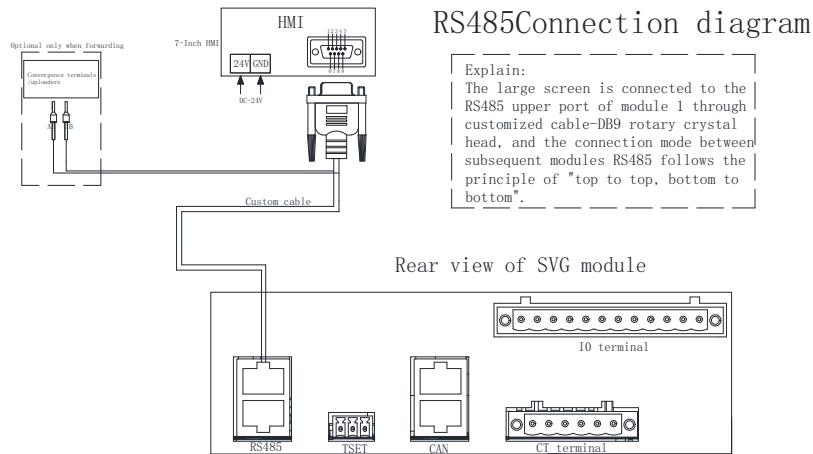

Appendix Figure 2-1 New version

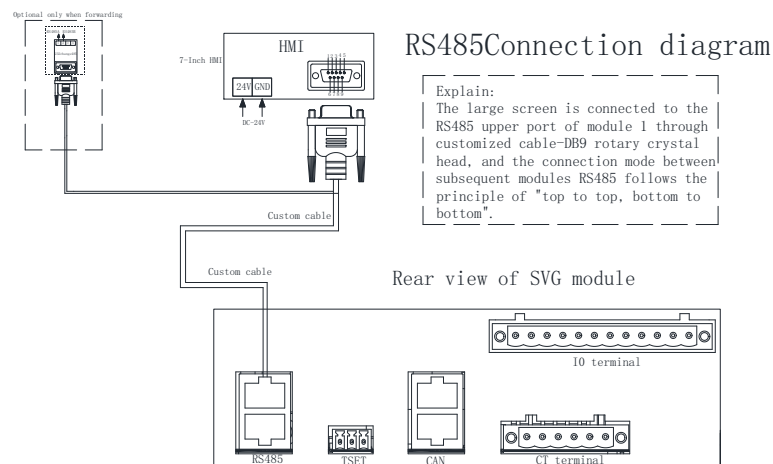

Appendix Figure 2-2 Old version

When data is forwarded through the large screen, the master head interface of the large screen can be connected through the DB9 male head at one end of the customized cable, and the 8P crystal head at the other end is connected to the RS485 upper port of the SVG device. There is also a set of 485 signals on the large screen that can be connected to the upper computer or background terminal through the customized cable. The new version has the same cable forwarding effect as the old version.

(2) SVG device forwarding

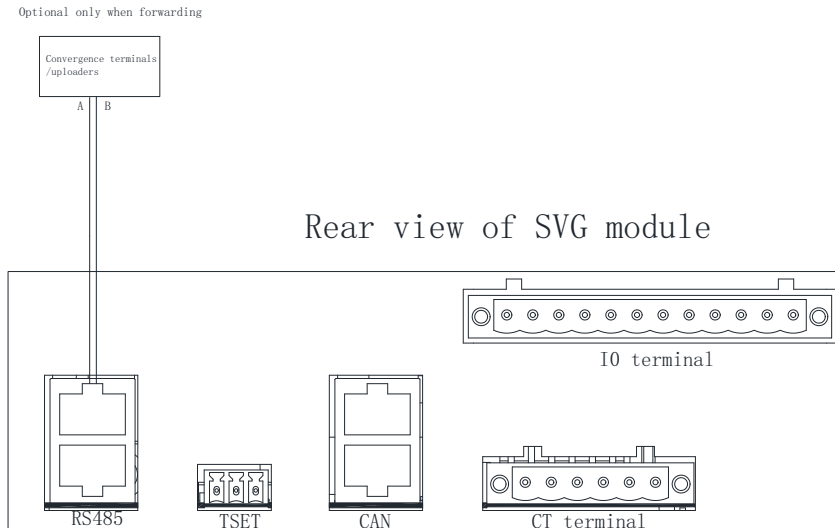

Appendix Figure 2-3 Module Forwarding

When the SVG device transfers the large screen, the 8P crystal head is connected to the RS485 port of the SVG device at the end of the customized cable, and the other end is the RS485 line, and the 485A / 485B is connected to the upper computer or the background terminal to realize data forwarding.

3. Comep Mode

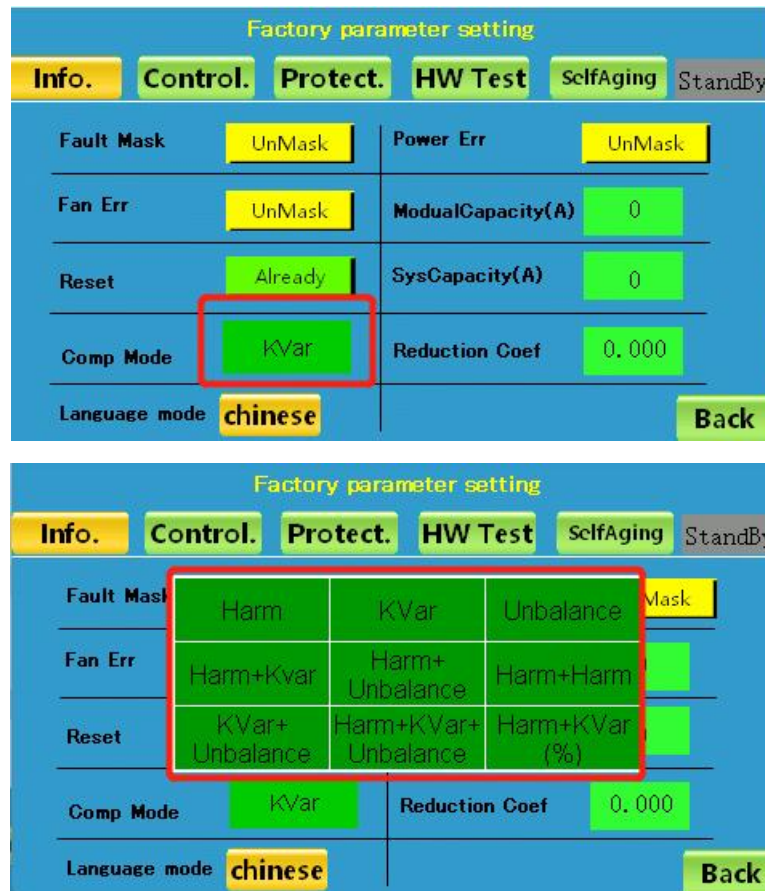

Appendix Figure 3-1 Mode Settings

The compensation mode can be set by logging in as a special user, the default setting for SVG is "KVar" mode. You can switch to other compensation modes by clicking on them.

The special user login method is as follows. In general, please do not login to this interface at will to avoid malfunction or damage to the equipment due to misuse, please operate under the guidance of an engineer.

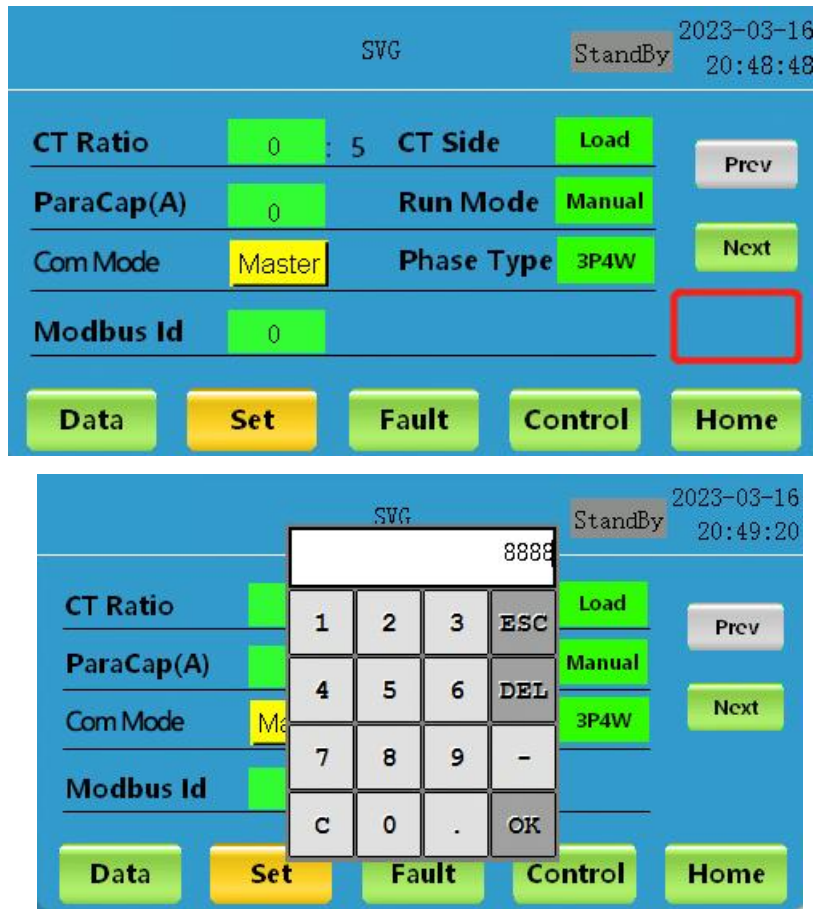

Appendix Figure 3-2 Logging in as a Special User